

Catalogo Porte blindate
Security doors catalog
Catalogue portes blindées

OTC[®]
DOORS

INDUSTRIA TOSCANA PORTE

Innovativi per tradizione

1975



La tradizione artigianale toscana incontra l'esperienza della famiglia Fedi. Nasce OTC snc, azienda specializzata nella commercializzazione e distribuzione di porte interne, infissi e serramenti per il mercato nazionale.

The Tuscan craftsmanship tradition meets the Fedi family's experience. OTC Snc was established, a Company specializing in the distribution of internal doors and windows for the national market.

La tradition artisanale toscane s'unit à l'expérience de la famille Fedi. Voici OTC snc, une société spécialisée dans la commercialisation et la distribution de portes internes, d'huisseries et de châssis sur le marché Italien.

2005



OTC DOORS costruisce a Serravalle Pistoiese un nuovo impianto produttivo con una superficie di oltre 4.000 mq e tecnologia di ultima generazione per incrementare le performance e gli standard qualitativi dei propri prodotti.

OTC DOORS constructed a new manufacturing plant in Serravalle Pistoiese, which covers an area of 4000 square meters, with next-generation technology to raise the performance and quality of its products.

La nouvelle usine de OTC DOORS, distribuée sur plus de 4.000 m2 de surface, se situe à Serravalle Pistoiese; on l'a équipée de technologie de toute dernière génération afin d'améliorer les performances et les standards de ses propres produits en termes de qualité.



2000

OTC Snc diventa OTC DOORS Srl. Si ampliano gli stabilimenti e le strutture commerciali per rispondere in modo efficace alle esigenze di mercati sempre più ampi e internazionali.

OTC snc turns into OTC DOORS Srl. New sites and new sales facilities are opened to effectively meet the need of increasingly large and international markets.

OTC Snc est devenu OTC DOORS Srl. Les établissements et les structures commerciales se sont agrandies pour mieux répondre à des exigences de marché de plus en plus vastes et globales.



2014

Nasce ITP Srl, acronimo di Industria Toscana Porte, che produce e distribuisce i prodotti a marchio OTC DOORS. La nuova Società segna il passaggio generazionale alla direzione dell'azienda dal fondatore ai figli e ai nuovi soci, che ricoprono e seguono direttamente le principali funzioni del processo progettuale, produttivo, commerciale e finanziario.

ITP Srl was established as an acronym for Industria Toscana Porte, which manufactures and distributes OTC DOORS brand products. The new Company marks a generational shift from the founder to his sons and new partners, who hold and directly follow the main features of the design, production, trade and financial processes.

Nous vous présentons ITP Srl, acronyme de Industria Toscana Porte, laquelle produit et distribue les produits de la marque OTC DOORS. Cette nouvelle Société marque le passage générationnel du fondateur qui confie la direction à ses enfants et aux nouveaux associés, lesquels occupent les principales fonctions liées à la conception, la production, aux aspects commercial et financier, qu'ils suivent directement.

Made in Toscana, Italia

Made in Tuscany, Italy Made in Toscana, Italie

Lo stabilimento produttivo di Serravalle Pistoiese, che si estende su una superficie di 4000 mq, è il quartier generale dove prendono forma le creazioni firmate OTC DOORS.

Questo impianto accoglie un innovativo sistema di lavorazione a isole con macchinari automatizzati ad alta precisione capaci di realizzare con la stessa efficienza sia produzioni in serie che commesse personalizzate anche in piccoli quantitativi. Dalla progettazione all'assemblaggio, dal controllo qualità alla spedizione in tutto il mondo: ogni fase del processo produttivo è seguita direttamente dalla proprietà avvalendosi di personale altamente specializzato, a garanzia di prodotti che sono il frutto di un perfetto mix tra tecnologia e tradizione, degni interpreti dell'eccellenza Made in Italy.

Lo stabilimento accoglie inoltre un ampio showroom interno dove agenti, rivenditori, progettisti e i loro clienti finali possono toccare con mano la qualità dei prodotti e valutare in anteprima le ultime novità OTC DOORS.

OTC DOORS constructed a new manufacturing plant in Serravalle Pistoiese, which covers an area of 4000 square meters, where OTC DOORS brand products are created.

This plant accommodates an innovative multi-level processing system with high precision automated machinery to achieve the same mass production efficiency and custom orders even in small quantities.

From design to assembly, from quality control to shipping all over the world: each stage of the production process is followed directly by the estate with highly specialized personnel, to guarantee products which blend technology and tradition, representing the excellence Made in Italy.

The plant also includes a large internal showroom where agents, retailers, designers and their end customers can have a hands-on experience of the products' quality and assess the first preview of the latest OTC DOORS products.

L'usine de Serravalle Pistoiese, de plus de 4000 m2 de surface constitue le quartier général ; c'est là que les créations signées OTC DOORS prennent vie.

Ce site accueille un système d'usinage à îlots tout à fait novateur ainsi que des machines automatisées, de très grande précision, capables de traiter tout aussi bien les productions en série que les commandes personnalisées, en plus petites quantités, avec le même soin.

De la conception à l'assemblage, du contrôle qualité aux livraisons, partout dans le monde: chaque phase du processus de production est suivie directement par les propriétaires qui peuvent vanter un personnel hautement spécialisé, à garantie de produits qui sont le fruit d'un parfait mélange entre technologie et tradition, dignes interprètes de l'excellence Made in Italy.

L'établissement accueille également un vaste showroom interne où les agents, les revendeurs, les concepteurs et leurs clients de destination pourront juger personnellement de la qualité des produits et, en avant-première, évaluer les toutes dernières nouveautés de la Société OTC DOORS.



OTC DOORS per l'ambiente

OTC DOORS for the environment OTC DOORS et l'environnement

La sostenibilità ambientale e il rispetto della salute umana sono valori fondamentali per OTC DOORS che si impegna attivamente attraverso scelte consapevoli nel proprio impianto produttivo, come l'impiego di energia da fonti rinnovabili con una riduzione sostanziale delle emissioni di CO2. L'impianto fotovoltaico installato presso il nostro stabilimento è in grado di soddisfare il fabbisogno energetico annuo dell'azienda e di oltre 50 famiglie.

Environmental sustainability and safeguarding human health are fundamental values for OTC DOORS which is consciously involved in its own production facility, such as the use of energy from renewable sources with a substantial reduction in CO2 emissions. The photovoltaic system installed at our factory can meet the annual energy requirements of the company and over 50 families.

La durabilité environnementale et le respect pour la santé humaine sont des valeurs fondamentales pour notre Société laquelle, au sein de sa propre usine, s'est engagée à travers des choix conscients tels que, par exemple, l'emploi d'énergies renouvelables et donc une réduction considérable des émissions de CO2. L'équipement photovoltaïque installé permet de satisfaire les besoins annuels de l'entreprise en énergie mais de 50 autres familles également.

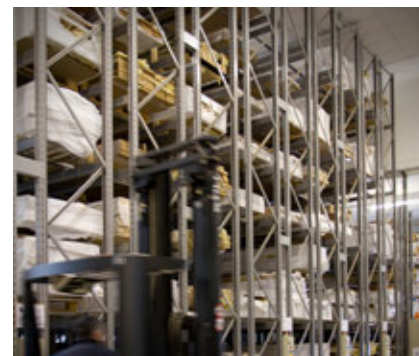
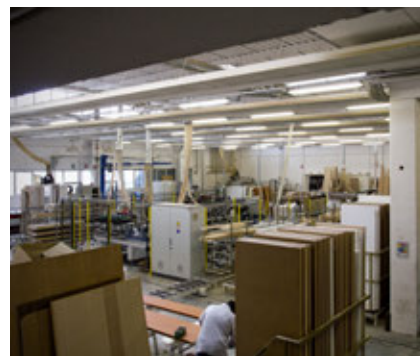
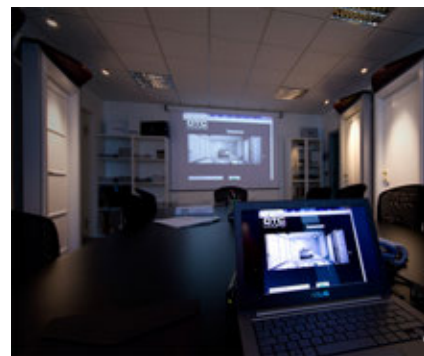



Proteggi il tuo mondo

Proteggi il tuo mondo

Le porte blindate Security di OTC DOORS sono pensate per soddisfare tutte le esigenze in termini di estetica e sicurezza unendo tecnologia e design per fare della vostra porta un vero elemento di arredo con infinite possibilità di personalizzazione.

Protect your world

The Security OTC DOORS armored doors are designed to meet all requirements in terms of aesthetics and safety by combining technology and design to make your door a true piece of furniture with infinite possibilities.

Protégez votre monde

La sécurité de OTC DOORS portes blindées sont conçus pour répondre à toutes les exigences en termes d'esthétique et de sécurité en combinant technologie et design pour rendre votre porte un véritable meuble avec des possibilités infinies.

Indice



pag. 10 CREA LA TUA PORTA

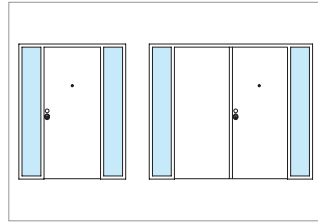

pag. 54 STRUTTURE

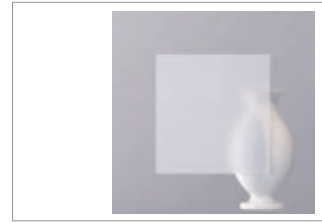

pag. 55 VETRI



pag. 56 DOMOTICA



pag. 60 PANNELLI



pag. 62 VENTIVENTI



pag. 66 READY DOORS



pag. 68 OTELLO



pag. 72 SEGNO



pag. 76 STILE



pag. 80 BUTTERFLY



pag. 84 BUTTERFLY "V"



pag. 88 TOSCA



pag. 90 TOSCA "M"

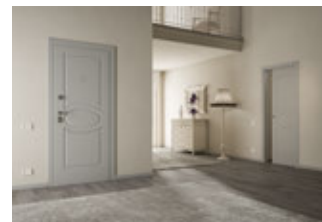

pag. 94 TURANDOT

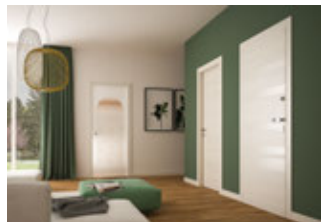

pag. 98 DUAL - Modern



pag. 102 DUAL - Vintage



pag. 104 DUAL - Tosca

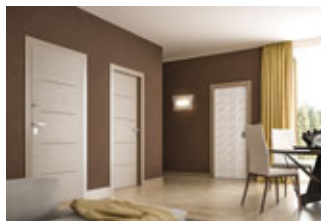

pag. 106 DUAL Butterfly e Butterfly V



pag. 108 DUAL Butterfly New

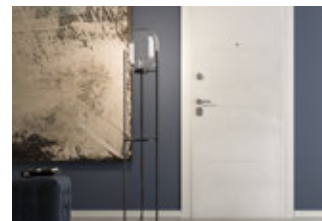

pag. 110 DUAL Segno



pag. 112 DUAL Stile



pag. 114 GRANDUCATO

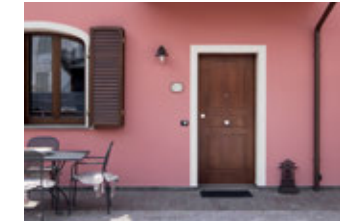

pag. 118 ATHENA



pag. 122 CRONO



pag. 124 DIONISO



pag. 128 HERA

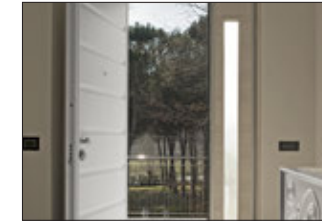

pag. 130 HERMES



pag. 132 URANO



pag. 134 APOLLO

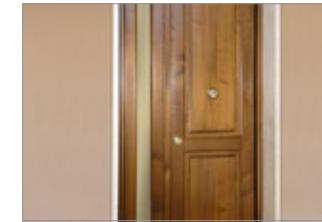

pag. 138 GRANDUCATO MASSELLO



pag. 140 ARES



pag. 142 GIOVE



pag. 146 POSEIDONE



pag. 154 STONE

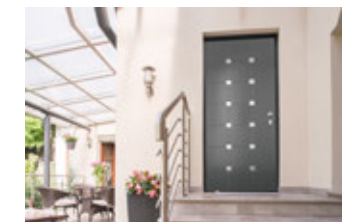

pag. 158 STAINLESS



pag. 164 AFRODITE



pag. 190 POMOLI E MANIGLIE



pag. 198 CILINDRI



pag. 200 ESSENZE E FINITURE

Crea la tua porta

La porta d'ingresso, insieme alle porte interne assumono un aspetto sempre più importante per l'interior design globale della casa, diventando un vero e proprio elemento d'arredo. Per questa ragione OTC DOORS ha sviluppato il sistema OTC DOORS SECURITY, un programma di portoni estremamente versatile e flessibile che permette di scegliere l'aspetto e la funzionalità della porta blindata per assecondare le esigenze estetiche sia negli ambienti classici che in quelli moderni. Le strutture blindate sono pensate per accogliere una vasta gamma di rivestimenti interni ed esterni, anche diversi tra di loro, sia coordinati completamente con le porte interne che su disegno esclusivo e personalizzato del cliente.

Create your door
The front door, along with the interior doors are playing an increasingly important aspect of the overall interior design of the house, becoming a real piece of furniture. For this reason OTC DOORS has developed the OTC DOORS SECURITY System, a program of gates and doors versatile and flexible that lets you choose the appearance and functionality of the security door in both the classic and in modern ones.
The armored structures are designed to accommodate a wide range of internal and external coatings, also different from each other, is completely coordinated with the interior doors of exclusive and personalized design of the customer.

Créez votre porte
La porte d'entrée, ainsi que les portes intérieures jouent un aspect de plus en plus important de la conception globale d'intérieur de la maison, devenir un véritable meuble. Pour cette raison OTC DOORS a développé le système de sécurité OTC DOORS, un programme de portails et portes souples et flexibles qui vous permet de choisir l'apparence et la fonctionnalité de la porte de sécurité à la fois classiques et modernes.
Les structures blindées sont conçus pour accueillir une large gamme de revêtements internes et externes, aussi différents les uns des autres, est complètement coordonnés avec les portes intérieures de design exclusif et personnalisé du client.



rivestimento esterno
external panels
panneaux externes



struttura blindata
structure (Elide o Nerea)
structure (Elide o Nerea)



rivestimento interno
interior panels
panneaux intérieurs



La porta blindata può essere composta con finiture e modelli diversi per il pannello interno e quello esterno, in modo da assecondare esigenze di gusto e architettoniche, per esempio all'interno di condomini e immobili con particolari requisiti estetici.

The security door can be made with different finishes and patterns for the inner panel and the outer one, in order to satisfy requirements of taste and architectural, for example inside of condominiums and property with special aesthetic requirements.

La porte de sécurité peut être faite avec différentes finitions et modèles pour le panneau intérieur et l'enveloppe extérieure, afin de satisfaire aux exigences du goût et de l'architecture, par exemple à l'intérieur des condominiums et des biens avec des exigences esthétiques particulières.

Tutte le strutture blindate OTC DOORS SECURITY hanno la certificazione anti intrusione secondo la normativa Europea Uni En 1627-30: metodo di prova e classificazione, classe 3 e 4. Sono inoltre certificate per la permeabilità all'aria (Uni En 1026, metodo di prova, Uni En 12207, classificazione, classe 1) e per la resistenza al vento (Uni En 12211 metodo di prova, Uni En 12210 classificazione, classe C5).

All OTC DOORS SECURITY armoured structures have anti-intrusion certification according to European Uni En 1627-30 Standards; with class 3 and 4 testing methods and classification. Furthermore, they are certified for permeability to air (Uni En 1026, testing method, Uni En 12207 classification, class 1) and for resistance to wind (Uni En 12211 methods of testing, Uni En 12210 classification, class 5).

Toutes les structures blindées OTC DOORS SECURITY ont la certification anti-intrusion conformément à la réglementation européenne Uni En 1627-30 : méthode d'essai et classification, classe 3 et 4. Elles sont également certifiées pour la perméabilité à l'air (Uni En 1026, méthode d'essai, Uni En 12207, classification, classe 1) et pour la résistance au vent (Uni En 12211 méthode d'essai, Uni En 12210 classification, classe C5).

Il pannello di rivestimento interno può essere coordinato con le porte interne, applicando la stessa finitura anche a battiscopa, imbotte e coprifilo. OTC DOORS consente inoltre di personalizzare, su richiesta, i pannelli di rivestimento con un disegno originale fornito dal cliente.

The inner lining panel can be coordinated with the interior doors, applying the same even finish skirting board, frame and architrave. OTC DOORS also allows you to customize, on demand, the covering panels with an original design provided by the customer.

Le panneau de doublure intérieure peut être coordonnée avec les portes intérieures, en appliquant la même, même finir plinthe, cadre et architrave. OTC DOORS permet également de personnaliser, sur demande, les panneaux de revêtement avec un design original fourni par le client.

Due strutture blindate e infinite soluzioni

Two armored structures and infinite solutions

Deux structures blindées et d'infinies solutions

 classe 4

Elide

1 anta



La porta blindata ELIDE in classe anti-effrazione C4 può essere realizzata solo nella versione a un'anta: dispone di struttura verniciata (di serie RAL 8019) con cerniere a vista e ferma-pannello interno in legno coordinato con la finitura del pannello. Le parti vetrate, qualora presenti, possono avere larghezza massima di 24 cm.

Elide 1 door

The ELIDE security door with class 4 anti-intrusion classification, can only be made in the single door version. It has a painted structure (of the RAL 8019 series), with visible fittings and internal wooden panel closure trims coordinated with the finish of the panel. The glass parts, where present, may only have a maximum width of 24 cm.

Elide 1 porte

La porta blindata ELIDE appartenente alla classe anti-effrazione C4 ne peut être réalisée que dans la version avec un vantail: elle dispose d'une structure peinte (de série RAL 8019) avec des charnières à vue et un bloque-panneau interne en bois assorti à la finition du panneau. Les parties en verre, si elles sont présentes, peuvent avoir une largeur maximale de 24 cm.

Prestazioni Features Prestazioni	di serie standard de série	opzionali optional optionnel
Classe anti intrusione Break-in class Classe anti-effraction	4	-
Isolamento acustico Acoustic insulation Insonorisation	31 dB	45 dB
Isolamento termico U U thermal insulation Isolation thermique U	2,44 W/m²K	1,30 W/m²K
Resistenza all'aria Air resistance Résistance de l'air	1	-
Resistenza al vento Wind resistance Résistance au vent	5	-

Nerea

1 anta



La porta blindata NEREA in classe anti-effrazione C4 può essere realizzata solo nella versione a un'anta: dispone di struttura verniciata con ferma-pannello in metallo e cerniere a scomparsa, unite al coprifilo coordinato con la stessa finitura del pannello interno. Le parti vetrate, qualora presenti, possono avere larghezza massima di 24 cm.

Nerea 1 and 2 doors

The NEREA security door with class 4 anti-intrusion classification, can only be made in the single door version. It has a painted metal panel closure trims and hidden hinges, coupled with the casing coordinated with the same finish as the internal panel. The glass parts, where present, may only have a maximum width of 24 cm.

Nerea 1 et 2 portes

La porta blindata NEREA appartenente alla classe anti-effrazione C4 ne peut être réalisée que dans la version avec un vantail: elle dispose d'une structure peinte avec un bloque-panneau en métal et des charnières escamotables, combinées au chambranle assorti avec la même finition que le panneau interne. Les parties en verre, si elles sont présentes, peuvent avoir une largeur maximale de 24 cm.

Prestazioni Features Prestazioni	di serie standard de série	opzionali optional optionnel
Classe anti intrusione Break-in class Classe anti-effraction	4	-
Isolamento acustico Acoustic insulation Insonorisation	31 dB	45 dB
Isolamento termico U U thermal insulation Isolation thermique U	2,44 W/m²K	1,30 W/m²K
Resistenza all'aria Air resistance Résistance de l'air	1	-
Resistenza al vento Wind resistance Résistance au vent	5	-

Due strutture blindate e infinite soluzioni

Two armored structures and infinite solutions

Deux structures blindées et d'infinies solutions

 classe 3

Elide

1 e 2 ante



La porta blindata ELIDE, in classe anti-effrazione C3, disponibile nelle versioni ad una e due ante, è caratterizzata dalla struttura verniciata con cerniere a vista e dal fermapannello interno in legno coordinato con la finitura del pannello.

Elide 1 and 2 doors

The ELIDE security door, with class C3 anti-intrusion classification, available in one or two door versions, is distinguished by its painted structure with visible hinges and with an internal wooden panel closure trims coordinated with the finish of the panel.

Elide 1 et 2 portes

La porte blindée ELIDE appartenant à la classe anti-effraction C3, disponible dans les versions avec un ou deux vantaux, est caractérisée par la structure peinte avec des charnières à vue et par le bloque-panneau interne en bois assorti à la finition du panneau.

Prestazioni Features Prestazioni	di serie standard de série	opzionali optional optionnel
Classe anti intrusione Break-in class Classe anti-effraction	3	-
Isolamento acustico Acoustic insulation Insonorisation	31 dB	45 dB
Isolamento termico U U thermal insulation Isolation thermique U	2,44 W/m²K	1,30 W/m²K
Resistenza all'aria Air resistance Résistance de l'air	1	-
Resistenza al vento Wind resistance Résistance au vent	5	-

Nerea

1 e 2 ante



La struttura verniciata con fermapannello in metallo e cerniere a scomparsa, unite al coprifilo coordinato con la stessa finitura del pannello interno donano alla porta NEREA, in classe anti-effrazione C3, disponibile ad 1 e 2 ante, un aspetto minimale e contemporaneo.

Nerea 1 and 2 doors

The painted structure with metal panel closure trims and hidden hinges, united with the casing coordinated with the same finish as the internal panel, impart to the NEREA door, as an anti-intrusion class C3 and available as a 1 or 2 door unit, a minimal and contemporary aspect.

Nerea 1 et 2 portes

La structure peinte avec un bloque-panneau en métal et des charnières intégrées, combinées au chambranle assorti avec la même finition que le panneau interne donnent à la porte NEREA, de classe anti-effraction C3, disponible avec 1 ou 2 portes, un aspect minimaliste et contemporain.

Prestazioni Features Prestazioni	di serie standard de série	opzionali optional optionnel
Classe anti intrusione Break-in class Classe anti-effraction	3	-
Isolamento acustico Acoustic insulation Insonorisation	31 dB	45 dB
Isolamento termico U U thermal insulation Isolation thermique U	2,44 W/m²K	1,30 W/m²K
Resistenza all'aria Air resistance Résistance de l'air	1	-
Resistenza al vento Wind resistance Résistance au vent	5	-

Interni Coordinati

Armonia ed eleganza sono alla base del concetto proposto da OTC DOORS per coordinare la porta blindata con il resto delle porte interne, grazie alla possibilità di avere il pannello interno, porte tuttovetro, coprifili e battiscopa delle stesse finiture della collezione VENTIVENTI.

Harmony and elegance are the basis of the concept proposed by OTC DOORS to coordinate the security door with the rest of the internal doors, thanks to the possibility of having the internal panel, all glass doors, backlining and skirting of the same finishes as the VENTIVENTI collection.

L'harmonie et l'élégance sont à la base du concept proposé par OTC DOORS pour coordonner la porte blindée avec le reste des portes intérieures, grâce à la possibilité d'avoir le panneau intérieur, portes tout en verre, cache-fils et plinthe des mêmes finitions que la collection VENTIVENTI.



WA4 - WB4

Finitura GESSO, vetro Foglie Verdi
GESSO finishing, foglie Verdi glass
Finition GESSO, verre Foglie Verdi

WA3 - WB3

Finitura GESSO
GESSO finishing
Finition GESSO

PORTA BLINDATA NEREA
SECURITY DOOR NEREA
PORTE DE SÉCURITÉ NEREA

Rivestimento interno WA3 - WB3 GESSO
Internal panel WA3 - WB3 GESSO
Panneaux intérieur WA3 - WB3 GESSO

Interni Coordinati

Armonia ed eleganza sono alla base del concetto proposto da OTC DOORS per coordinare la porta blindata con il resto delle porte interne, grazie alla possibilità di avere il pannello interno, porte tuttovetro, coprifili e battiscopa delle stesse finiture della collezione VENTIVENTI.

Harmony and elegance are the basis of the concept proposed by OTC DOORS to coordinate the security door with the rest of the internal doors, thanks to the possibility of having the internal panel, all glass doors, backlining and skirting of the same finishes as the VENTIVENTI collection.

L'harmonie et l'élégance sont à la base du concept proposé par OTC DOORS pour coordonner la porte blindée avec le reste des portes intérieures, grâce à la possibilité d'avoir le panneau intérieur, portes tout en verre, cache-fils et plinthe des mêmes finitions que la collection VENTIVENTI.

PORTA BLINDATA NEREA
SECURITY DOOR NEREA
PORTE DE SÉCURITÉ NEREA

Rivestimento interno WA3 - WB3 PIUMA
Internal panel WA3 - WB3 PIUMA
Panneaux intérieur WA3 - WB3 PIUMA

WA3 - WB3

Filo imbottito, finitura PIUMA
Blockboard coplanair, PIUMA finishing
Bâti coplanaires, finition PIUMA

WA3 - WB3

Filo imbottito, finitura PIUMA
Blockboard coplanair, PIUMA finishing
Bâti coplanaires, finition PIUMA

Interni Coordinati

Armonia ed eleganza sono alla base del concetto proposto da OTC DOORS per coordinare la porta blindata con il resto delle porte interne, grazie alla possibilità di avere il pannello interno, porte tuttovetro, coprifili e battiscopa delle stesse finiture della collezione SEGNO.

Harmony and elegance are the basis of the concept proposed by OTC DOORS to coordinate the security door with the rest of the internal doors, thanks to the possibility of having the internal panel, all glass doors, backlining and skirting of the same finishes as the SEGNO collection.

L'harmonie et l'élégance sont à la base du concept proposé par OTC DOORS pour coordonner la porte blindée avec le reste des portes intérieures, grâce à la possibilité d'avoir le panneau intérieur, portes tout en verre, cache-fils et plinthe des mêmes finitions que la collection SEGNO.



SEGNO 310

Laccato RAL 5001
Lacquered RAL 5001
Laqué RAL 5001

TUTTOVETRO

Porta a battente, laccato RAL 5001, vetro Nest
Hinged door, lacquered RAL 5001, Nest glass
Porte battante, laqué RAL 5001, verre Nest

PORTA BLINDATA ELIDE

SECURITY DOOR ELIDE
PORTE DE SÉCURITÉ ELIDE

Rivestimento interno SEGNO 310, laccato RAL 5001
Internal panel SEGNO 310, lacquered RAL 5001
Panneaux intérieur SEGNO 310, laqué RAL 5001

Interni Coordinati

Armonia ed eleganza sono alla base del concetto proposto da OTC DOORS per coordinare la porta blindata con il resto delle porte interne, grazie alla possibilità di avere il pannello interno, porte tuttovetro, coprifili e battiscopa delle stesse finiture della collezione VENTIVENTI.

Harmony and elegance are the basis of the concept proposed by OTC DOORS to coordinate the security door with the rest of the internal doors, thanks to the possibility of having the internal panel, all glass doors, backlining and skirting of the same finishes as the VENTIVENTI collection.

L'harmonie et l'élégance sont à la base du concept proposé par OTC DOORS pour coordonner la porte blindée avec le reste des portes intérieures, grâce à la possibilité d'avoir le panneau intérieur, portes tout en verre, cache-fils et plinthe des mêmes finitions que la collection VENTIVENTI.

PORTA BLINDATA NEREA
SECURITY DOOR NEREA
PORTE DE SÉCURITÉ NEREA

Rivestimento interno WA3 - WB3 CALCE
Internal panel WA3 - WB3 CALCE
Panneaux intérieur WA3 - WB3 CALCE

WA3 - WB3

Raso muro, Finitura CALCE
Flush wall, CALCE finishing
Invisible, finition CALCE

WA3 - WB3

Raso muro, Finitura CALCE
Flush wall, CALCE finishing
Invisible, finition CALCE

Interni Coordinati

Armonia ed eleganza sono alla base del concetto proposto da OTC DOORS per coordinare la porta blindata con il resto delle porte interne, grazie alla possibilità di avere il pannello interno, porte tuttovetro, coprifili e battiscopa delle stesse finiture della collezione DUAL.

Harmony and elegance are the basis of the concept proposed by OTC DOORS to coordinate the security door with the rest of the internal doors, thanks to the possibility of having the internal panel, all glass doors, backlining and skirting of the same finishes as the DUAL collection.

L'harmonie et l'élégance sont à la base du concept proposé par OTC DOORS pour coordonner la porte blindée avec le reste des portes intérieures, grâce à la possibilité d'avoir le panneau intérieur, portes tout en verre, cache-fils et plinthe des mêmes finitions que la collection DUAL.



Porta blindata NEREA
Security door NEREA
Porte de sécurité NEREA

Rivestimento interno D12 Laccato RAL 9003 sabbato orizzontale
Internal panel D12 Lacquered RAL 9003 sabbato orizzontale
Panneaux intérieur D12 Laqué RAL 9003 sabbato orizzontale

D12
DUAL
sabbato orizzontale

Laccato RAL 9003
Lacquered RAL 9003
Laqué RAL 9003

D12
DUAL
sabbato orizzontale

Laccato RAL 9003
Lacquered RAL 9003
Laqué RAL 9003

Interni Coordinati

Armonia ed eleganza sono alla base del concetto proposto da OTC DOORS per coordinare la porta blindata con il resto delle porte interne, grazie alla possibilità di avere il pannello interno, porte tuttovetro, coprifili e battiscopa delle stesse finiture della collezione DUAL.

Harmony and elegance are the basis of the concept proposed by OTC DOORS to coordinate the security door with the rest of the internal doors, thanks to the possibility of having the internal panel, all glass doors, backlining and skirting of the same finishes as the DUAL collection.

L'harmonie et l'élégance sont à la base du concept proposé par OTC DOORS pour coordonner la porte blindée avec le reste des portes intérieures, grâce à la possibilité d'avoir le panneau intérieur, portes tout en verre, cache-fils et plinthe des mêmes finitions que la collection DUAL.



TUTTO VETRO

Laccato RAL 9010, scorrevole a scomparsa, vetro Tramonto
Lacquered RAL 9010, fully-retracting sliding door, Tramonto glass
Laqué RAL 9010, porte coulissante escamotable, verre Tramonto

D11 DUAL sabbiato orizzontale

Laccato RAL 9010
Lacquered RAL 9010
Laqué RAL 9010

Porta blindata NEREA Security door NEREA Porte de sécurité NEREA

Rivestimento interno D11 Laccato RAL 9010 sabbiato orizzontale
Internal panel D11 Lacquered RAL 9010 sabbiato orizzontale
Panneaux intérieur D11 Laqué RAL 9010 sabbiato orizzontale

Interni Coordinati

Armonia ed eleganza sono alla base del concetto proposto da OTC DOORS per coordinare la porta blindata con il resto delle porte interne, grazie alla possibilità di avere il pannello interno, porte tuttovetro, coprifili e battiscopa delle stesse finiture della collezione DUAL.

Harmony and elegance are the basis of the concept proposed by OTC DOORS to coordinate the security door with the rest of the internal doors, thanks to the possibility of having the internal panel, all glass doors, backlining and skirting of the same finishes as the DUAL collection.

L'harmonie et l'élégance sont à la base du concept proposé par OTC DOORS pour coordonner la porte blindée avec le reste des portes intérieures, grâce à la possibilité d'avoir le panneau intérieur, portes tout en verre, cache-fils et plinthe des mêmes finitions que la collection DUAL.



**D13
DUAL
sabbiato verticale**
Laccato RAL 7038
Lacquered RAL 7038
Laqué RAL 7038

**D13
DUAL
sabbiato verticale**
Laccato RAL 7038
Lacquered RAL 7038
Laqué RAL 7038

**Porta blindata NEREA
Security door NEREA
Porte de sécurité NEREA**

Rivestimento interno D13 Laccato RAL 7038 sabbiato verticale
Internal panel D13 Lacquered RAL 7038 sabbiato verticale
Panneaux intérieur D13 Laqué RAL 7038 sabbiato verticale

Interni Coordinati

Armonia ed eleganza sono alla base del concetto proposto da OTC DOORS per coordinare la porta blindata con il resto delle porte interne, grazie alla possibilità di avere il pannello interno, porte tuttovetro, coprifili e battiscopa delle stesse finiture della collezione DUAL.

Harmony and elegance are the basis of the concept proposed by OTC DOORS to coordinate the security door with the rest of the internal doors, thanks to the possibility of having the internal panel, all glass doors, backlining and skirting of the same finishes as the DUAL collection.

L'harmonie et l'élégance sont à la base du concept proposé par OTC DOORS pour coordonner la porte blindée avec le reste des portes intérieures, grâce à la possibilité d'avoir le panneau intérieur, portes tout en verre, cache-fils et plinthe des mêmes finitions que la collection DUAL.



**D25
DUAL**
sabbaiato orizzontale

Laccato RAL 9002
Lacquered RAL 9002
Laqué RAL 9002

**Porta blindata NEREA
Security door NEREA
Porte de sécurité NEREA**

Rivestimento interno D25 Laccato RAL 9002 sabbaiato orizzontale
Internal panel D25 Lacquered RAL 9002 sabbaiato orizzontale
Panneaux intérieur D25 Laqué RAL 9002 sabbaiato orizzontale

Interni Coordinati

Armonia ed eleganza sono alla base del concetto proposto da OTC DOORS per coordinare la porta blindata con il resto delle porte interne, grazie alla possibilità di avere il pannello interno, porte tuttovetro, coprifili e battiscopa delle stesse finiture della collezione DUAL.

Harmony and elegance are the basis of the concept proposed by OTC DOORS to coordinate the security door with the rest of the internal doors, thanks to the possibility of having the internal panel, all glass doors, backlining and skirting of the same finishes as the DUAL collection.

L'harmonie et l'élégance sont à la base du concept proposé par OTC DOORS pour coordonner la porte blindée avec le reste des portes intérieures, grâce à la possibilité d'avoir le panneau intérieur, portes tout en verre, cache-fils et plinthe des mêmes finitions que la collection DUAL.



TUTTO VETRO

Laccato RAL 9010, scorrevole a scomparsa, vetro Astratto blu
Lacquered RAL 9010, fully-retracting sliding door, Astratto blu glass
Laqué RAL 9010, porte coulissante escamotable, verre Astratto blu

D44 DUAL sabbiato orizzontale

Laccato RAL 9010
Lacquered RAL 9010
Laqué RAL 9010

Porta blindata NEREA Security door NEREA Porte de sécurité NEREA

Rivestimento interno D44 Laccato RAL 9010 sabbiato orizzontale
Internal panel D44 Lacquered RAL 9010 sabbiato orizzontale
Panneaux intérieur D44 Laqué RAL 9010 sabbiato orizzontale

Interni Coordinati

Armonia ed eleganza sono alla base del concetto proposto da OTC DOORS per coordinare la porta blindata con il resto delle porte interne, grazie alla possibilità di avere il pannello interno, porte tuttovetro, coprifili e battiscopa delle stesse finiture della collezione BUTTERFLY.

Harmony and elegance are the basis of the concept proposed by OTC DOORS to coordinate the security door with the rest of the internal doors, thanks to the possibility of having the internal panel, all glass doors, backlining and skirting of the same finishes as the BUTTERFLY collection.

L'harmonie et l'élégance sont à la base du concept proposé par OTC DOORS pour coordonner la porte blindée avec le reste des portes intérieures, grâce à la possibilité d'avoir le panneau intérieur, portes tout en verre, cache-fils et plinthe des mêmes finitions que la collection BUTTERFLY.

TUTTO VETRO

Laccato RAL 1013, scorrevole a scomparsa, vetro Alpaca
Lacquered RAL 1013, fully-retracting sliding door, Alpaca glass
Laqué RAL 1013, porte coulissante escamotable, verre Alpaca

V04

Laccato RAL 1013
Lacquered RAL 1013
Laqué RAL 1013

Porta blindata NEREA
Security door NEREA
Porte de sécurité NEREA

Rivestimento interno V04 Laccato RAL 1013
Internal panel V04 Lacquered RAL 1013
Panneaux intérieur V04 Laqué RAL 1013

Interni Coordinati

Armonia ed eleganza sono alla base del concetto proposto da OTC DOORS per coordinare la porta blindata con il resto delle porte interne, grazie alla possibilità di avere il pannello interno, porte tuttovetro, coprifili e battiscopa delle stesse finiture della collezione TOSCA.

Harmony and elegance are the basis of the concept proposed by OTC DOORS to coordinate the security door with the rest of the internal doors, thanks to the possibility of having the internal panel, all glass doors, backlining and skirting of the same finishes as the TOSCA collection.

L'harmonie et l'élégance sont à la base du concept proposé par OTC DOORS pour coordonner la porte blindée avec le reste des portes intérieures, grâce à la possibilité d'avoir le panneau intérieur, portes tout en verre, cache-fils et plinthe des mêmes finitions que la collection TOSCA.

TUTTOVETRO

Laccato RAL 7036, scorrevole a scomparsa, vetro Mondrian
Lacquered RAL 7036, fully-retracting sliding door, Mondrian glass
Laqué RAL 7036, porte coulissante escamotable, verre Mondrian

M03

Laccato RAL 7036, imbottito Raggio 2
Lacquered RAL 7036, Raggio 2 blockboard
Laqué RAL 7036, bâti Rayon 2

Porta blindata NEREA
Security door NEREA
Porte de sécurité NEREA

Rivestimento interno M03 Laccato Ral 7036
Internal panel M03 Lacquered RAL 7036
Panneaux intérieur M03 Laqué RAL 7036

Interni Coordinati

Armonia ed eleganza sono alla base del concetto proposto da OTC DOORS per coordinare la porta blindata con il resto delle porte interne, grazie alla possibilità di avere il pannello interno, porte tuttovetro, coprifili e battiscopa delle stesse finiture della collezione BUTTERFLY.

Harmony and elegance are the basis of the concept proposed by OTC DOORS to coordinate the security door with the rest of the internal doors, thanks to the possibility of having the internal panel, all glass doors, backlining and skirting of the same finishes as the BUTTERFLY collection.

L'harmonie et l'élégance sont à la base du concept proposé par OTC DOORS pour coordonner la porte blindée avec le reste des portes intérieures, grâce à la possibilité d'avoir le panneau intérieur, portes tout en verre, cache-fils et plinthe des mêmes finitions que la collection BUTTERFLY.

Porta blindata NEREA
Security door NEREA
Porte de sécurité NEREA

Rivestimento interno V08 Laccato RAL 9001
Internal panel V08 Lacquered RAL 9001
Panneaux intérieur V08 Laqué RAL 9001

V08 Laccato RAL9001
Lacquered RAL 9001
Laqué RAL 9001

Interni Coordinati

Armonia ed eleganza sono alla base del concetto proposto da OTC DOORS per coordinare la porta blindata con il resto delle porte interne, grazie alla possibilità di avere il pannello interno, porte tuttovetro, coprifili e battiscopa delle stesse finiture della collezione OTELLO.

Harmony and elegance are the basis of the concept proposed by OTC DOORS to coordinate the security door with the rest of the internal doors, thanks to the possibility of having the internal panel, all glass doors, backlining and skirting of the same finishes as the OTELLO collection.

L'harmonie et l'élégance sont à la base du concept proposé par OTC DOORS pour coordonner la porte blindée avec le reste des portes intérieures, grâce à la possibilité d'avoir le panneau intérieur, portes tout en verre, cache-fils et plinthe des mêmes finitions que la collection OTELLO.



Porta blindata NEREA
Security door NEREA
Porte de sécurité NEREA

Rivestimento interno Laccato RAL 9003
Internal panel Lacquered RAL 9003
Panneaux intérieur Laqué RAL 9003

251

Laccato RAL 9003, imbotte Raggio 2 con cerniera a scomparsa
Lacquered RAL 9003, blockboard door Radius 2 with invisible hinges
Laqué RAL 9003, bâti Rayon 2 avec charnières invisibles

251

Filo imbotte, Laccato RAL 9003
Blockboard coplanar, Lacquered RAL 9003
Bâti coplanaires, Laqué RAL 9003

Interni Coordinati

Armonia ed eleganza sono alla base del concetto proposto da OTC DOORS per coordinare la porta blindata con il resto delle porte interne, grazie alla possibilità di avere il pannello interno, porte tuttovetro, coprifili e battiscopa delle stesse finiture della collezione OTELLO.

Harmony and elegance are the basis of the concept proposed by OTC DOORS to coordinate the security door with the rest of the internal doors, thanks to the possibility of having the internal panel, all glass doors, backlining and skirting of the same finishes as the OTELLO collection.

L'harmonie et l'élégance sont à la base du concept proposé par OTC DOORS pour coordonner la porte blindée avec le reste des portes intérieures, grâce à la possibilité d'avoir le panneau intérieur, portes tout en verre, cache-fils et plinthe des mêmes finitions que la collection OTELLO.



278 Noce Nazionale Tinto Medio
Italian Walnut Dyed Medium
Italian Walnut Dyed Medium

TUTTO VETRO Noce Nazionale Tinto Medio, porta a battente, vetro Iris carta
Italian Walnut Dyed Medium, hinged door, Iris carta glass
Italian Walnut Dyed Medium, porte battante, verre Iris carta

Porta blindata ELIDE
Security door ELIDE
Porte de sécurité ELIDE

Rivestimento interno 278 Noce Nazionale Tinto Medio
Internal panel 278 Italian Walnut Dyed Medium
Panneaux intérieur 278 Italian Walnut Dyed Medium

Interni Coordinati

Armonia ed eleganza sono alla base del concetto proposto da OTC DOORS per coordinare la porta blindata con il resto delle porte interne, grazie alla possibilità di avere il pannello interno, porte tuttovetro, coprifili e battiscopa delle stesse finiture della collezione GRANDUCATO.

Harmony and elegance are the basis of the concept proposed by OTC DOORS to coordinate the security door with the rest of the internal doors, thanks to the possibility of having the internal panel, all glass doors, backlining and skirting of the same finishes as the GRANDUCATO collection.

L'harmonie et l'élégance sont à la base du concept proposé par OTC DOORS pour coordonner la porte blindée avec le reste des portes intérieures, grâce à la possibilité d'avoir le panneau intérieur, portes tout en verre, cache-fils et plinthe des mêmes finitions que la collection GRANDUCATO.



574 Castagno Decò L2
Chestnut Decò L2
Châtaigne Decò L2

576 Castagno Decò L2, vetro molato satinato bianco
Chestnut Decò L2, satin-finish cut glass
Châtaigne Decò L2, verre moulé satiné blanc

Porta blindata NEREA
Security door NEREA
Porte de sécurité NEREA

Rivestimento interno 574 Castagno Decò L2
Internal panel 574 Decò L2 Chestnut
Panneaux intérieur 574 Châtaigne Decò L2

Disegni esclusivi e personalizzabili

Per chi ama distinguersi OTC DOORS SECURITY propone numerosi disegni esclusivi, anche su progetto personalizzato, per rendere ogni porta un elemento di arredo di grande personalità, in grado di inserirsi sia negli ambienti classici che in quelli moderni.

Il sistema OTC DOORS SECURITY è inoltre studiato per assecondare anche le più complesse esigenze legate a progetti prestigiosi, dove gli aspetti della sicurezza devono confrontarsi con soluzioni architettoniche complesse che prevedono l'integrazione con serramenti, infissi, inferriate, porte da garage e complementi realizzati su misura.

EXCLUSIVE AND CUSTOM DESIGNS

For those who love to stand OTC DOORS SECURITY offers a range of exclusive designs, also on project, to make each brings an element of great personality furniture, able to fit both the classic and in modern ones.

The OTC DOORS SECURITY system is also designed to satisfy even the most complex requirements pertaining to prestigious projects, where safety aspects are confronted with complex architectural solutions that provide integration with doors, windows, railings, garage doors and accessories made of measure.

Designs exclusifs et CUSTOM

Pour ceux qui aiment se tenir OTC DOORS SECURITY offre une gamme de modèles exclusifs, également sur le projet, de faire chacun apporte un élément de grande meubles de la personnalité, en mesure de répondre à la fois classiques et modernes.

Le système OTC DOORS sécurité est également conçu pour satisfaire aux exigences les plus complexes se rapportant à des projets prestigieux, où les aspects de sécurité sont confrontés à des solutions architecturales complexes qui fournissent l'intégration avec portes, fenêtres, grilles, portes de garage et accessoires en mesurer.

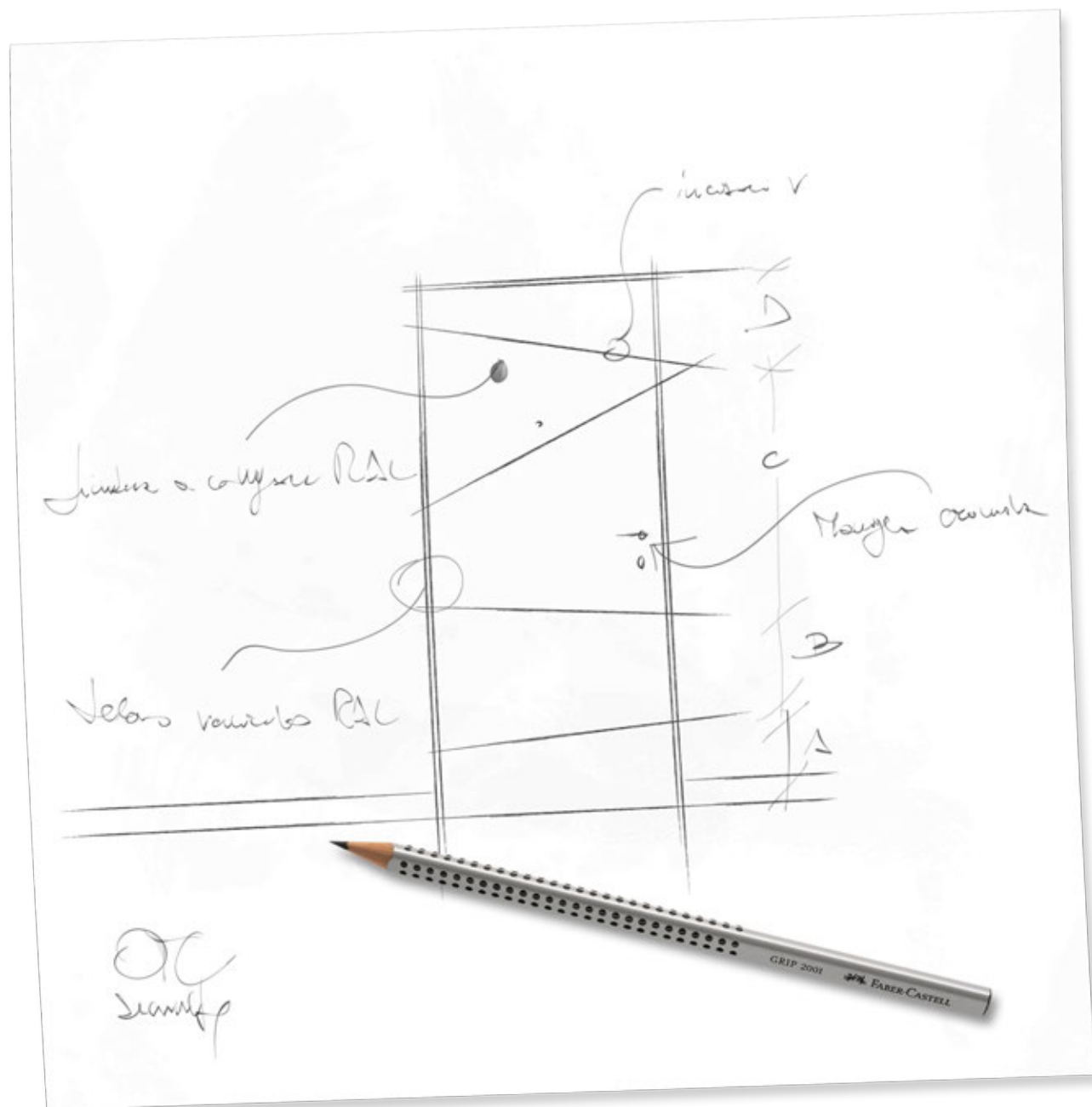

Porta blindata ELIDE
Security door ELIDE
Porte de sécurité ELIDE

Porta blindata con pannello interno inciso collezione Butterfly
Security door with engrave inside panel Butterfly
Porte de sécurité avec panneau interne collection Butterfly

Dettagli che fanno la differenza

Ferma-pannello, imbotte e coprifilo sono coordinati con la finitura del pannello, disponibile nelle essenze delle linee di porte interne OTC DOORS, nella gamma dei colori RAL e in molte altre finiture. I telai metallici possono essere verniciati in tutti i colori RAL, anche bicolore (interno ed esterno differenti). Il sistema SECURITY di OTC DOORS garantisce attenzione a tutti i dettagli di rifinitura per un risultato di alta qualità, frutto dell'esperienza ultradecennale maturata nel settore.

Details that make the difference
 Stop-panel, frame and architrave are coordinated with the panel finish, available in the essences of the lines of OTC DOORS interior doors, in the range of RAL colors and many other finishes. The metal frames can be painted in all RAL colors, even two-tone (inside and outside different). The Security system OTC DOORS guarantees attention to all the finishing details for a high quality result, the result of ten years of experience in the industry.

Les détails qui font la différence
 Arrêtez-panneau, cadre et architrave sont coordonnés avec la finition du panneau, disponible dans les essences des lignes de OTC DOORS de portes intérieures, dans la gamme de couleurs RAL et de nombreuses autres finitions. Les cadres métalliques peuvent être peints dans toutes les teintes RAL, même à deux tons (à l'intérieur et à l'extérieur différent). Le système de sécurité OTC DOORS garantit attention à tous les détails de finition pour un résultat de haute qualité, le résultat de dix années d'expérience dans l'industrie.

Finiture coordinate Coordinated finish Finition coordonnée

- Guarnizione telaio muro mm 12x13 (opzionale)
Frame seal wall 12x13 mm (optional)
Paroi de joint Frame 12x13 mm (en option)
- Telaio metallico verniciato anche bicolore (opzionale)
Painted metal frame, also bicolor (optional)
Cadre en métal peint, également deux tons (en option)
- Fermapannello interno
Stop internal panel
Arrêter panneau intérieur
- Imbotte e coprifilo (opzionale)
Backlining frame extensions (optional)
Multicouche de cadre dormant (en option)
- Coibentazione termico-acustica in lana di roccia (opzionale)
Rock wool additional insulation (optional)
Isolation supplémentaire en laine de roche (en option)

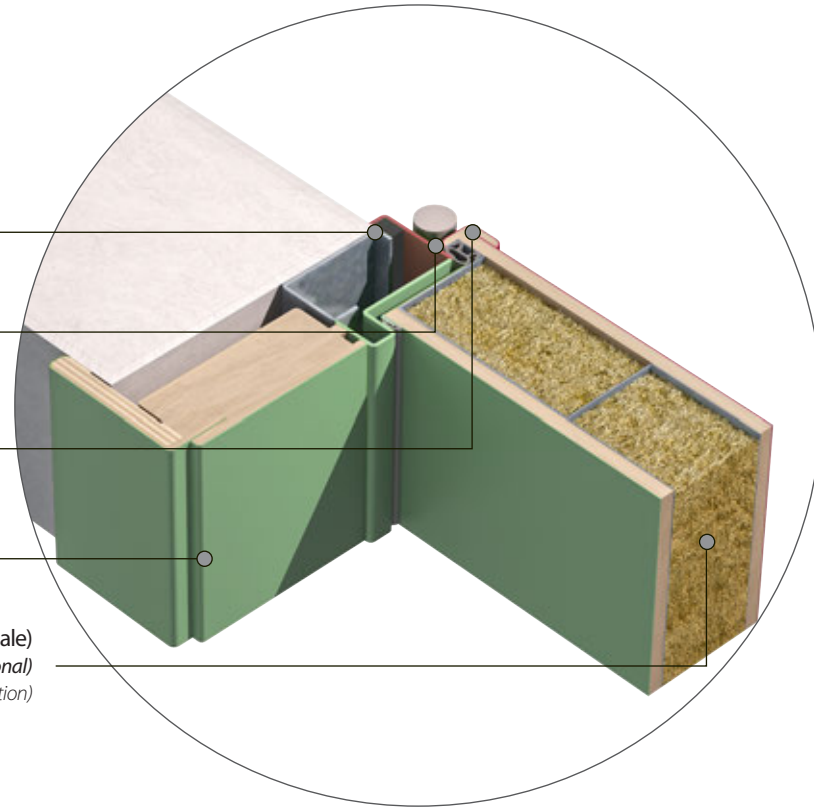

Telaio metallico
 Metal frame
 Cadre en métal



RAL 8019 (standard)

Altri colori RAL su richiesta
 Other RAL colors on request
 Autres couleurs RAL sur demande

Fermapannello coordinato con la finitura del pannello, sia con colori RAL che nelle essenze delle linee OTC DOORS
Blocking profiles coordinated with the finish of the panel, both with RAL colors which in essences lines OTC DOORS
Blocage des profils coordonnés avec la finition du panneau, à la fois avec des couleurs RAL qui, dans les essences des lignes OTC DOORS



Soluzioni su misura per la tua casa

Porte a due o tre ante, con e senza vetro, sopra-
luce fisso o ad arco, visiva laterale in vetro, porte in pendenza, dimensioni fuori standard: qualunque sia l'esigenza funzionale, il sistema OTC DOORS SECURITY dispone di numerosi modelli e varianti per le strutture blindate che, con l'impiego di vetro antiproiettile (opzionale), garantiscono il mantenimento della classe di sicurezza 3. Per conservare la classe anti-effrazione C4, il portone deve essere realizzato a una sola anta e le parti vetrate possono avere larghezza massima di 24 cm.

Entry with two or three doors, with and without glass, fixed or arched fanlight, see through glass sidelights, angled doors, non-standard dimensions; whatever the functional requirement, the OTC DOORS SECURITY system has numerous models and variants available for security structures. With the use of bullet proof glass (optional), they guarantee the maintenance of class 3 safety. In order to keep class 4 anti-intrusion protection, the entrance must be made of only one door, and the glass panels may be no wider than 24 cm.

Portes avec deux ou trois vantaux, avec et sans verre, imposte fixe ou en forme d'arc, visuel latéral en verre, porte en forme de trapèze, dimensions non standards: quel que soit le besoin fonctionnel, le système OTC DOORS SECURITY dispose de nombreux modèles et variantes pour les structures blindées qui, avec l'utilisation d'un verre pare-balles (en option), garantissent le maintien de la classe de sécurité 3. Pour conserver la classe anti-effraction C4, la grande porte doit être réalisée avec un seul vantail et les parties en verre peuvent avoir une largeur maximum de 24 cm.



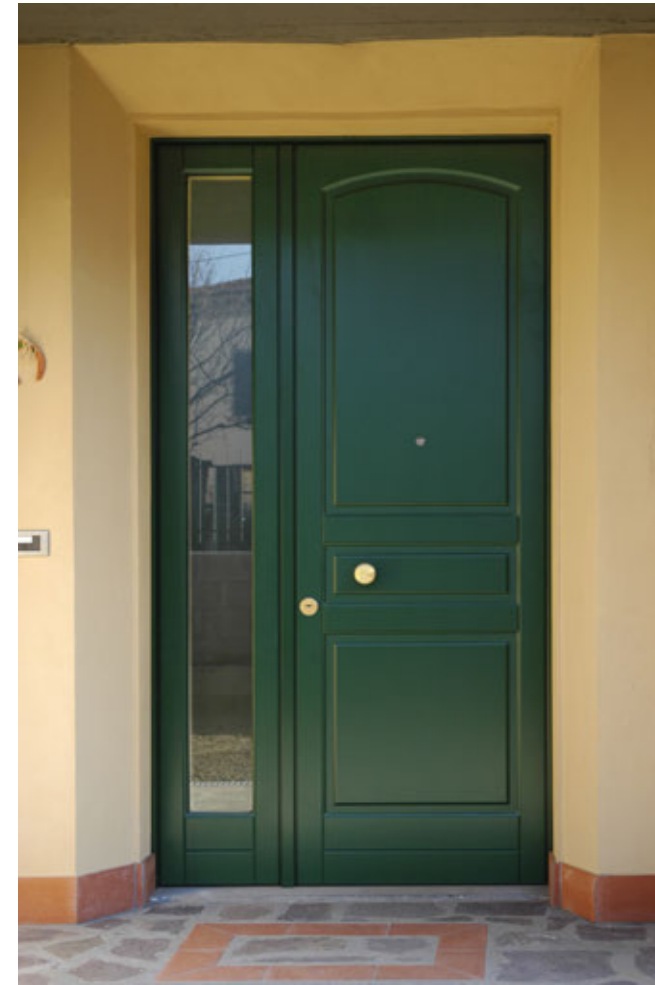
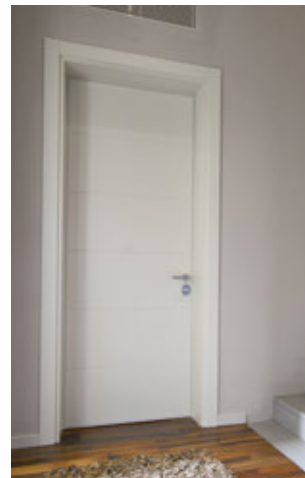
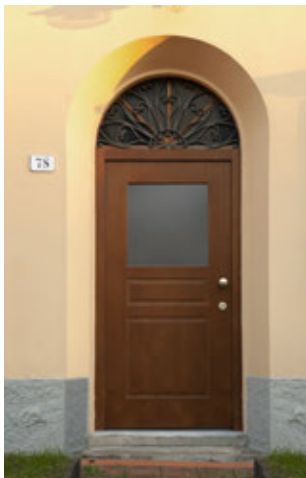
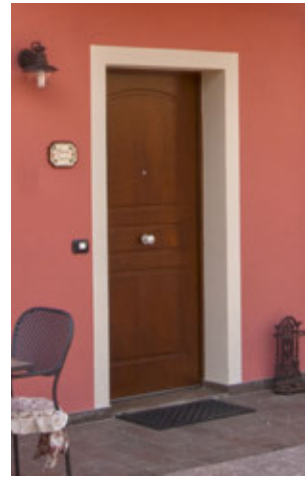

Soluzioni strutture

Il sistema OTC DOORS SECURITY dispone di numerosi modelli e varianti per le strutture blindate Elide e Nerea, per risolvere in maniera impeccabile qualsiasi esigenza funzionale ed estetica.

The OTC DOORS SECURITY system has many models and variants Elis and Nerea armored structures, impeccably solve any functional and aesthetic requirements.

Le système de sécurité de gré à gré PORTES a de nombreux modèles et variantes structures blindées Elis et Nerea, résoudre impeccablement toutes les exigences fonctionnelles et esthétiques.

Tipologia ante
Door typology
Typologie ante



Vetro
Glass
Verre

Finestrature
Windows
Fenêtres

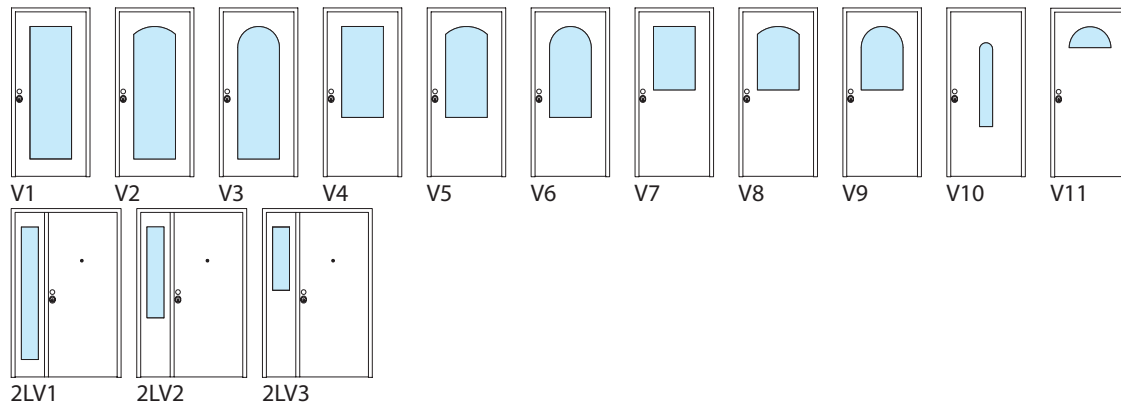

Sopraluce fisso
Fixed fanlight
Vasistas fixé

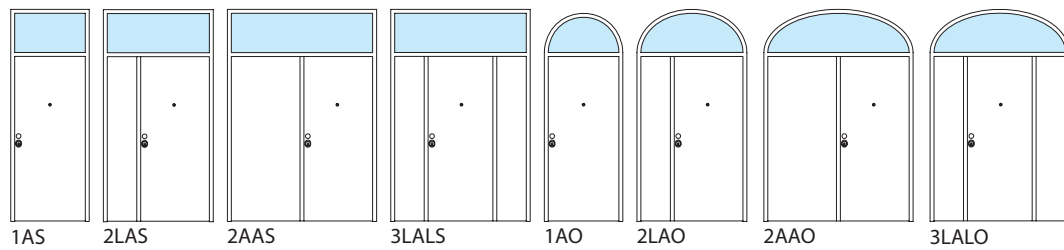

Visiva laterale fissa
fixed lateral windows
Fenêtres latérale fixé

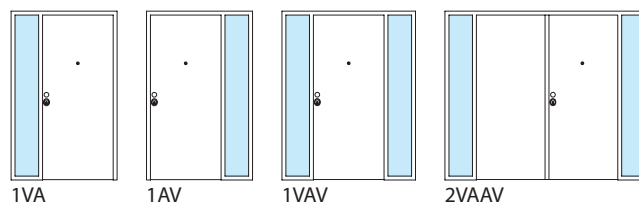

Visiva e sopraluce fissi
Fixed Windows
Fenêtres fixé

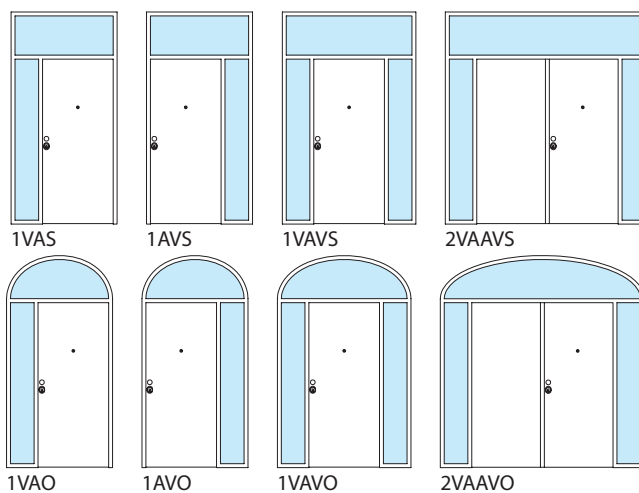

Vetri

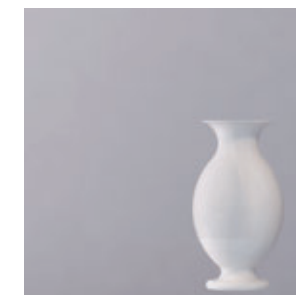

trasparente P01
transparent P20
transparentes

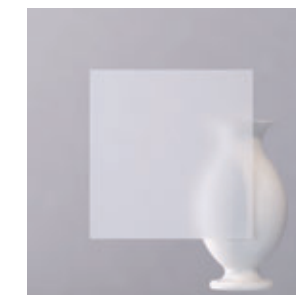

satinato P01
frosted P20
satiné

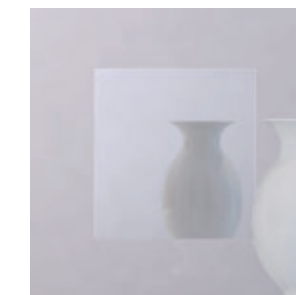

specchio P01
mirror P20
miroir



fumé trasparente P01
transparent smoked P20
fumé transparentes

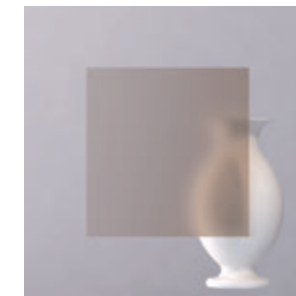

bronzo satinato P01
frosted bronze P20
bronze satiné

Composizione vetri
Glass composition
Composition de verres

* vetro 6/7 basso emissivo
* 6/7 low emissivity glass
* verre 6/7 à faible émissivité

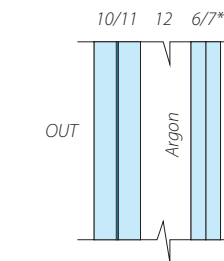

antisfondamento P01
shatterproof P20
incassable

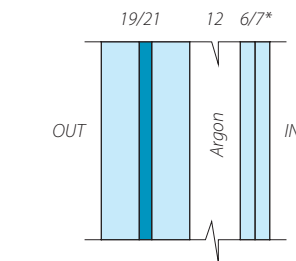

antiproiettile P20
bulletproof P20
pare-balles

Quando è previsto l'inserimento di vetro nei sopraluce e nelle visive laterali, oppure all'interno dell'anta, è possibile scegliere composizione e tipo di vetro. Quando non diversamente specificato all'ordine, il vetro montato di serie è un vetro antisfondamento con vetro camera (P01 28/30). Per conservare la certificazione antieffrazione classe 3 è necessario utilizzare vetro antiproiettile con vetro camera (P20 37/39), opzionali per i modelli Elide e Nerea. Per conservare la classe antieffrazione C4, inoltre, le parti vetrate possono avere larghezza massima di 24 cm.

- Vetro camera P01 28/30:
Antieffrazione Uni En 356: classe NPD**
Antivandalismo Uni En 356: classe NPD**
Resistenza agli urti Uni En 12600: classe 1B1
Trasmittanza termica Uni En 673: Ug = 1,6 W/m²k
Isolamento acustico (stimato): Rw 38 db±1

- Vetro camera P20 37/39:
Antieffrazione Uni En 356: classe P7B
Antivandalismo Uni En 356: classe P5A
Antiproiettile Uni En 1063: classe BR2/S
Trasmittanza termica: Ug=1,2 w/m²k
Isolamento acustico (stimato): Rw 45db

**Prestazione non dichiarata

When is the glass insert in the fanlight and side coupled to the visual security door, or inside the door, you can choose the composition and type of glass. Unless otherwise specified order, glass fitted as standard is an unbreakable glass with insulated glass (P01 28/30). To maintain certification Burglary Class 3 must be used bulletproof glass with insulated glass (P20 37/39), optional for Elis and Nerea models. Furthermore, in order to maintain class 4 anti-intrusion protection, the glass panels may be no wider than 24 cm.

- Vitrage 28/30 P01:
Cambriolage, un UNI EN 356: Classe NPD**
Vandal UNI EN 356: Classe NPD**
Résistance aux chocs UNI EN 12600: Classe 1B1
Coeff. de transmission thermique UNI EN 673: Ug = 1,6 W / m²K
absorption acoustique (estimation): Rw 38 dB ± 1

- Verre Chambre P20 37/39:
Cambriolage, un UNI EN 356: classe P7B
Vandal UNI EN 356: Classe P5A
Bulletproof Uni EN 1063: classe BR2 / S
coefficient de transmission thermique: Ug = 1,2 W / m²K
absorption acoustique (estimation): 45db Rw

** Performance unreported

Quand l'insert en verre dans l'imposte et le côté couplé à la porte de sécurité visuelle, ou à l'intérieur de la porte, vous pouvez choisir la composition et le type de verre. Sauf pour indication contraire, le verre monté en série est un verre incassable avec vitrage isolant (P01 28/30). Pour maintenir la certification cambriolage Classe 3 doit être utilisé verre pare-balles avec vitrage isolant (P20 37/39), en option pour les modèles Elis et Nerea. Pour conserver la classe anti-effraction C4, les parties en verre peuvent avoir une largeur maximum de 24 cm.

- Glazing 28/30 P01:
Burglary, a UNI EN 356: Class NPD**
Vandal Uni En 356: Class NPD**
Shock resistance UNI EN 12600: Class 1B1
Thermal transmittance Uni En 673: Ug = 1.6 W / m²k
Sound absorption (estimated): Rw 38 dB ± 1

- Glass Room P20 37/39:
Burglary, a UNI EN 356: class P7B
Vandal Uni En 356: Class P5A
Bulletproof Uni En 1063: class BR2 / S
Thermal transmittance: Ug = 1,2 w / m²k
Sound absorption (estimated): Rw 45db

** Performance pas signalés

Sistemi di chiusura - domotica

Serratura motorizzata per porte blindate con movimento motorizzato e controllo digitale con tastiera - telecomando - chiave



Guarda il video
Watch the movie
Regarder le film

L'arricchimento delle serrature con componenti elettronici di ultima generazione permette di rendere l'accesso alle nostre case più intelligente, pratico e sicuro, consentendo un importante salto di qualità nelle prestazioni offerte dai nostri prodotti. Le porte blindate OTC DOORS SECURITY sono in grado di riconoscerci, si aprono al nostro arrivo e si chiudono non appena siamo all'interno di casa nostra. Se vogliamo dialogano con il sistema di allarme e possono integrarsi con il sistema domotico con estrema facilità.

Closure systems - home automation

Motorized locks for security doors, with motorized movement and digital control having keyboard - remote control - keys.

Enhancing the locks with last generation electronic components allows for making access to our homes more intelligent, practical and secure, permitting an important qualitative leap in the performance offered by our products. OTC DOORS SECURITY security doors are able to recognise us, they open on our arrival and close as soon as we are in our home. If we wish, they communicate with the alarm system and can integrate with the smart home system with the greatest ease.

Systèmes de fermeture - domotique

Serrure motorisée pour portes blindées avec mouvement motorisé et contrôle numérique avec clavier - télécommande - clé.

L'enrichissement des serrures avec les tout derniers composants électroniques permet de rendre l'accès à nos maisons plus intelligent, pratique et sûr, ce qui permet un saut de qualité important au niveau des performances offertes par nos produits. Les portes blindées OTC DOORS SECURITY sont capables de nous reconnaître, souvent à notre arrivée et se ferment dès que nous sommes à l'intérieur de notre maison. Si nous voulons, elles dialoguent avec le système d'alarme et peuvent facilement s'intégrer au système domotique.

Vista esterna con tastiera

External view with keyboard

Vue extérieure avec clavier

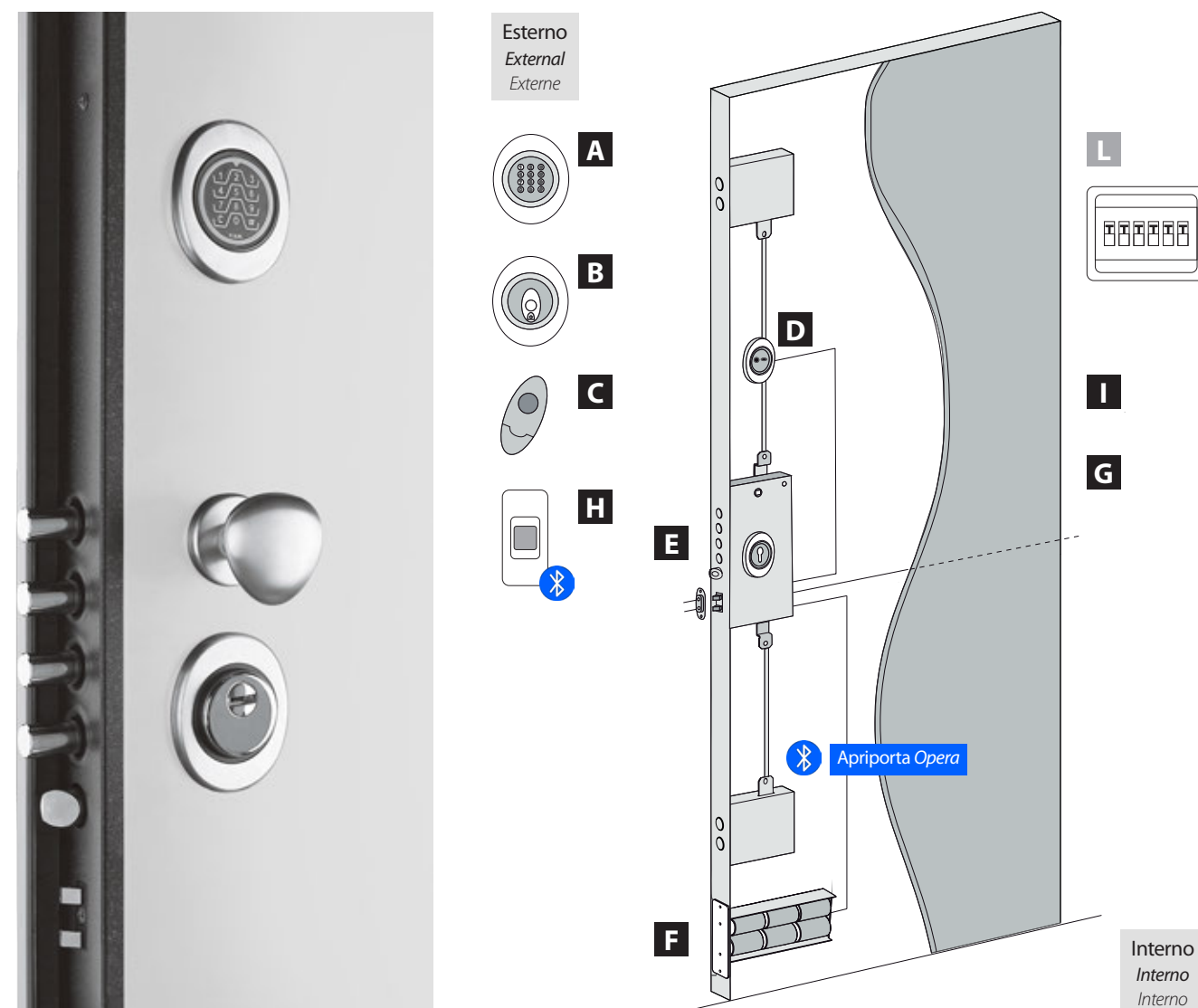

Componenti del sistema

System components

Composants du système

	A Tastiera esterna + lettore chiave TAG integrato External keyboard + Integrated TAG key player Clavier externe + Lecteur de clés TAG intégré		B Lettore esterno chiave TAG External player key TAG Lecteur externe Clé TAG		C Chiave TAG (padronale e di servizio) Key TAG (Main and service) Clé TAG (Principal et service)
	D Logica programmazione e pulsante di apertura interna Logic programming and internal opening button Logique programmation et bouton d'ouverture interne		E Serratura elettronica Electronic lock Serrure électronique		F Portabatterie Battery case Boîtier de batterie
	G Contatto elettrico per apertura remota Electric contact Contact électrique		H Lettore di impronte digitali Fingerprint reader Lecteur d'empreintes digitales		I Passacavo alimentazione da rete Mains power cable gland Presse-étoupe de câble d'alimentation secteur
	L Quadro elettrico (non fornito) Electrical cabinet (not provided) Armoire électrique (non fourni)		M Citofono (non fornito) Electrical cabinet (not provided) Armoire électrique (non fourni)		

Soluzioni di allestimento con alimentazione a rete o a batteria

Mains or battery powered racking solutions

Solutions de rayonnages sur secteur ou sur batterie

	1		2		3		4		5		
	Rete Mains Secteur	Batteria Battery Batterie	Rete Mains Secteur	Batteria Battery Batterie	Rete Mains Secteur	Batteria Battery Batterie	Rete Mains Secteur	Batteria Battery Batterie	Rete Mains Secteur	Batteria Battery Batterie	
D Logica programmazione e pulsante di apertura interna	✓	✓	✓	✓	✓	✓	✓	✓			INTERNO
E Serratura	✓	✓	✓	✓	✓	✓	✓	✓	✓	✓	
F Portabatterie		✓		✓		✓		✓		✓	
G Contatto elettrico per apertura remota	✓		✓		✓		✓	✓	✓	✓	
I Passacavo alimentazione da rete	✓		✓		✓		✓		✓		
L Quadro elettrico (non fornito)	✓		✓		✓		✓		✓		
A Tastiera esterna + lettore chiave TAG integrato			✓	✓	✓	✓					ESTERNO
B Lettore esterno chiave TAG	✓	✓	✓	✓							
C Chiave TAG (padronale e di servizio)	✓	✓	✓	✓							
D Logica programmazione e pulsante di apertura interna											
E Serratura elettronica	✓	✓	✓	✓	✓	✓	✓	✓	✓	✓	
M Citofono (non fornito)	✓		✓		✓		✓	✓	✓	✓	



Soluzione smart lock

Con il cilindro motorizzato NIO Zen hai la soluzione più confortevole e pratica per gestire gli accessi: la porta sarà sempre chiusa con tutte le sue mandate in totale sicurezza. Con NIO Zen non sono necessarie chiavi fisiche, perché è sufficiente utilizzare i dispositivi wireless dedicati, oppure integrarlo nel sistema di building automation preesistente. L'installazione può avvenire su qualsiasi porta, anche blindata dotata di cilindro europeo. Non richiede cablaggi od opere murarie. Il cilindro motorizzato NIO Zen è dotato di batterie ricaricabili.

Smart lock solution

With the NIO Zen motorized cylinder you have the most comfortable and practical solution to manage accesses: the door will always be closed with all its throws in total safety. With NIO Zen no physical keys are required, because it is sufficient to use the dedicated wireless devices, or integrate it into the existing building automation system. The installation can take place on any door, even armored with a European cylinder. It does not require wiring or building works. The NIO Zen motorized cylinder is equipped with rechargeable batteries.

Solution smart lock

Avec le cylindre motorisé NIO Zen, vous disposez de la solution la plus confortable et la plus pratique pour gérer les accès : la porte sera toujours fermée avec tous ses coups en toute sécurité. Avec NIO Zen, aucune clé physique n'est requise, car il suffit d'utiliser les dispositifs sans fil dédiés ou de les intégrer dans le système d'automatisation du bâtiment existant. L'installation peut avoir lieu sur n'importe quelle porte, même blindée avec un cylindre européen. Il ne nécessite ni câblage ni travaux de maçonnerie. Le cylindre motorisé NIO Zen est équipé de batteries rechargeables.



Smartphone

Tastierino

Telecomando

Lettore biometrico

Interfaccia terze parti

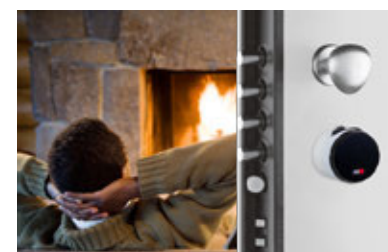

Per casa tua

È semplice da configurare, puoi farlo dal tuo smartphone o in auto-programmazione da altri dispositivi. Con NIO Zen non occorre connessione internet WIFI o GSM, né canone di gestione.

NIO Zen is for your home

It's simple to set up, you can do it from your smartphone or self-program from other devices. With NIO Zen you don't need a WIFI or GSM internet connection, or a management fee.

NIO Zen est pour votre maison

C'est simple à configurer, vous pouvez le faire à partir de votre smartphone ou vous programmer vous-même à partir d'autres appareils. Avec NIO Zen, vous n'avez pas besoin d'une connexion Internet WIFI ou GSM, ni de frais de gestion.

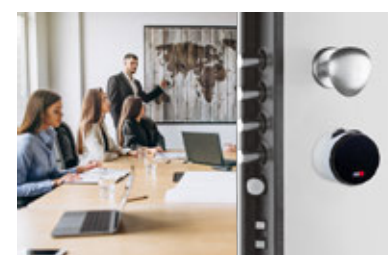

Per il tuo lavoro

Offre sicurezza e ti consente di avere un pieno controllo degli accessi. Ad ogni utente puoi assegnare autorizzazioni periodiche e orari specifici di apertura, inviando codici illimitati per te che sei Amministratore e per il tuo staff, o temporanei per ospiti. L'installazione può avvenire anche su porte di ingresso comuni e antincendio. In caso di emergenza, si apre sia dall'interno che dall'esterno. Il tuo business con NIO Zen sarà più efficiente e qualificato.

NIO Zen is for your work

It offers security and allows you to have full access control. You can assign each user periodic authorizations and specific opening hours, by sending unlimited codes for you as the Administrator and for your staff, or temporary codes for guests. The installation can also take place on common and fire doors. In case of emergency, it opens both from the inside and from the outside. Your business with NIO Zen will be more efficient and qualified.

NIO Zen est pour votre travail

Il offre une sécurité et vous permet d'avoir un contrôle d'accès complet. Vous pouvez attribuer à chaque utilisateur des autorisations périodiques et des heures d'ouverture spécifiques, en envoyant des codes illimités pour vous en tant qu'administrateur et pour votre personnel, ou des codes temporaires pour les invités. L'installation peut également avoir lieu sur des portes communes et coupe-feu. En cas d'urgence, il s'ouvre à la fois de l'intérieur et de l'extérieur. Votre entreprise avec NIO Zen sera plus efficace et qualifiée.

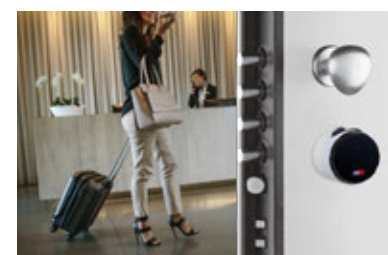

Per gestire strutture ricettive

NIO Zen è ideale per gestire appartamenti in affitto breve, B&B, residence o altre strutture ricettive. Eliminando il problema delle chiavi, potrai godere di indipendenza e comfort. È semplice da utilizzare: l'invio dei codici di accesso è gratuito e avviene via email, sms, whatsapp o a voce. Ti consente di gestire il check-in, l'orario di abilitazione e la scadenza dei codici in modo conveniente e flessibile. La tua struttura con NIO Zen migliorerà il suo ranking e brillerà per professionalità ed organizzazione.

NIO Zen is ideal for managing accommodation facilities

NIO Zen is ideal for managing short-term rental apartments, B & Bs, residences or other accommodation facilities. By eliminating the hassle of keys, you can enjoy independence and comfort. It is simple to use: access codes are sent free of charge and via email, sms, whatsapp or by voice. It allows you to manage check-in, activation time and code expiration in a convenient and flexible way. Your structure with NIO Zen will improve its ranking and will shine for professionalism and organization.

NIO Zen est idéal pour la gestion d'établissements d'hébergement

NIO Zen est idéal pour la gestion d'appartements en location courte durée, de chambres d'hôtes, de résidences ou d'autres structures d'hébergement. En éliminant le tracàs des clés, vous pouvez profiter de l'indépendance et du confort. Son utilisation est simple : les codes d'accès sont envoyés gratuitement et par email, sms, whatsapp ou à la voix. Il vous permet de gérer l'enregistrement, l'heure d'activation et l'expiration du code de manière pratique et flexible. Votre structure avec NIO Zen améliorera son classement et brillera par son professionnalisme et son organisation.



Cilindro motorizzato

Il cilindro motorizzato NIO Zen è dotato di chiavi brevettate a duplicazione protetta. L'installazione non richiede alcun cablaggio sulla porta. Le batterie ricaricabili garantiscono un lungo periodo di utilizzo senza ricarica. Il cilindro è modulare e può essere modificato in lunghezza in caso di sostituzione della porta.

The NIO Zen motorized cylinder is equipped with patented keys with protected duplication. The installation does not require any wiring on the window frame. Rechargeable batteries ensure a long period of use without recharging. The cylinder is modular and can be changed in length if the door is replaced.

Le cylindre motorisé NIO Zen est équipé de clés brevetées à duplication protégée. L'installation ne nécessite aucun câblage sur le cadre de la fenêtre. Les piles rechargeables garantissent une longue durée d'utilisation sans recharge. Le cylindre est modulaire et peut être modifié en longueur si la porte est remplacée.

Controllo accessi da smartphone

NIO Zen Basic App è lo strumento che ti consente di aprire e configurare il tuo cilindro motorizzato utilizzando esclusivamente il tuo smartphone. Disponibile gratuitamente su Play Store ed APP Store.

NIO Zen Basic App is the tool that allows you to open and configure your motorized knob using only your smartphone. Available for free on Play Store and APP Store.

NIO Zen Basic App est l'outil qui vous permet d'ouvrir et de configurer votre bouton motorisé en utilisant uniquement votre smartphone. Disponible gratuitement sur Play Store et APP Store.

Radiocomando

Radiocomando a tre pulsanti (apertura, chiusura parziale, chiusura completa) ad alta sicurezza, non duplicabile senza l'autorizzazione (tramite l'app) dell'Amministratore.

High security three-button remote control (opening, partial closing, complete closing), cannot be duplicated without the authorization (via the app) of the Administrator.

Télécommande à trois boutons de haute sécurité (ouverture, fermeture partielle, fermeture complète), ne peut pas être dupliquée sans l'autorisation (via l'application) de l'administrateur.

Tastiera numerica

La tastiera capacitiva NIO Zen wireless permette l'accesso alla struttura a tempo indeterminato con codici fissi personali oppure, utilizzando i codici OTP (One Time Password) solo per periodi determinati. Lavora con algoritmi interni per la generazione dei codici e così non richiede una connessione internet wifi.

The capacitive NIO Zen wireless keyboard allows access to the structure indefinitely with personal fixed codes or, using OTP (One Time Password) codes only for specific periods. It works with internal algorithms for generating the codes and thus does not require a wifi internet connection.

Le clavier sans fil capacitif NIO Zen permet d'accéder à la structure indéfiniment avec des codes fixes personnels ou, en utilisant des codes OTP (One Time Password) uniquement pour des périodes spécifiques. Il fonctionne avec des algorithmes internes pour générer les codes et ne nécessite donc pas de connexion internet wifi.

Tastiera numerica con lettore impronte digitali

Facile da installare, affidabile, senza fili e con attivazione a sfioramento, consente di memorizzare fino a 40 impronte digitali diverse, applicabile facilmente su qualsiasi superficie.

Easy to install, reliable, wireless and with touch activation, it allows you to store up to 40 different fingerprints, easily applicable on any surface.

Facile à installer, fiable, sans fil et avec activation tactile, il vous permet de stocker jusqu'à 40 empreintes digitales différentes, facilement applicables sur n'importe quelle surface.

Pannelli di rivestimento

Le porte blindate OTC DOORS SECURITY sono pensate per soddisfare tutte le esigenze di gusto e per fare della vostra porta un vero elemento di arredo con infinite possibilità di personalizzazione.

Dal rigoroso minimalismo al passionale ambiente mediterraneo, dal legno massello al PVC, una porta blindata OTC DOORS SECURITY si sposa perfettamente con tutti gli stili architettonici e di arredamento grazie alla grande varietà di pannelli di rivestimento disponibili, tutti realizzati con materiali altamente performanti.

Per i pannelli in legno, eventuali imperfezioni o variazioni di colore fanno parte del ciclo di vita naturale del vero legno e sono garanzia di qualità e autenticità del prodotto.

OTC DOORS SECURITY armored doors are designed to satisfy all taste needs and to make your door a real piece of furniture with infinite customization possibilities.

From rigorous minimalism to the passionate Mediterranean environment, from solid wood to PVC, an OTC DOORS Security armored door fits perfectly with all architectural and furnishing styles thanks to the great variety of cladding panels available, all made with high-performance materials.

For wooden panels, any imperfections or variations in color are part of the natural life cycle of real wood and are a guarantee of the quality and authenticity of the product.

Panneaux de revêtement OTC portes de sécurité portes blindées sont conçus pour répondre à toutes les exigences de goût et de faire votre porte un véritable meuble avec des possibilités infinies.

Minimalisme rigoureux pour l'environnement méditerranéen passionné, à partir de PVC solide à bois, une porte blindée OTC DOORS sécurité correspond parfaitement à tous les styles architecturaux et design d'intérieur grâce à la grande variété de disponibles bardages, tous fabriqués avec des matériaux de haute performance.

Pour les panneaux de bois, des imperfections ou des variations de couleurs font partie du cycle de la vie naturelle du bois et sont un gage de qualité et de l'authenticité du produit.

Materiali
Materials
Matériels



MDF

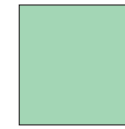

MDF idrofugo
Proof MDF
MDF étanche



Legno multistrato
Plywood
Bois Contre-plaqué

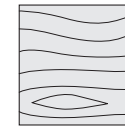

Legno massello
Solid wood
Bois massif



Alluminio con isolamento
Aluminum with insulation
Aluminium avec isolation

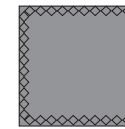

HDF Idro rivestito PVC
HDF Idro clad with PVC
HDF Idro habillé en PVC

Prestazioni
Performance
Performance



Installazione consentita soltanto all'interno
Installation only permitted inside
Installation seulement autorisé à l'intérieur



Installazione consentita all'esterno in luoghi riparati
Installation allowed outside in sheltered places
Installation permis l'extérieur dans des endroits abrités



Installazione consentita all'esterno
Installation allowed outside
Installation autorisée en dehors





VENTIVENTI



Modelli
Models
Modèles

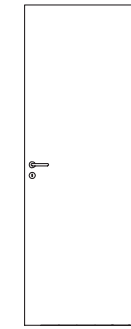

W1

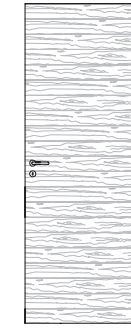

W3

GESSO, LATTE, CALCE, PIUMA, SANDALO, CORDA: 6 finiture ricercate ed esclusive, ispirate ad un sofisticato minimalismo orientale, vestono le porte della nuova collezione di OTC DOORS. Coordinabile con porte interne, imbotti e battiscopa.

GESSO, LATTE, CALCE, PIUMA, SANDALO, CORDA: 6 refined and exclusive finishes, inspired by a sophisticated oriental minimalism, dress the doors of the new OTC DOORS collection. Coordinates with internal doors, jamba and baseboards.

GESSO, LATTE, CALCE, PIUMA, SANDALO, CORDA: 6 finitions raffinées et exclusives, inspirées d'un minimalisme oriental sophistiqué, habillent les portes de la nouvelle collection OTC DOORS. Coordonne avec portes internes, les montants et les plinthes.

Finiture
Finishes
Finitions

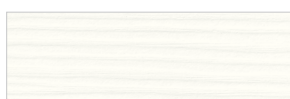

Gesso



Calce



Sandalo



Latte



Corda



Piuma

Sezione
Section
Section



READY DOORS



READY DOORS è una linea di pannelli in laminato dalle linee moderne ed essenziali, coordinabile con le porte interne per uno styling uniforme e armonizzato in tutta la casa.

READY DOORS is a line of laminate wood effect panels with modern lines and essential, coordinated with the interior doors for a uniform styling and coordinated throughout the house.

READY DOORS est une ligne de panneaux à effet de bois stratifié avec des lignes modernes et essentielles, en coordination avec les portes intérieures pour un style uniforme et coordonnée dans toute la maison.

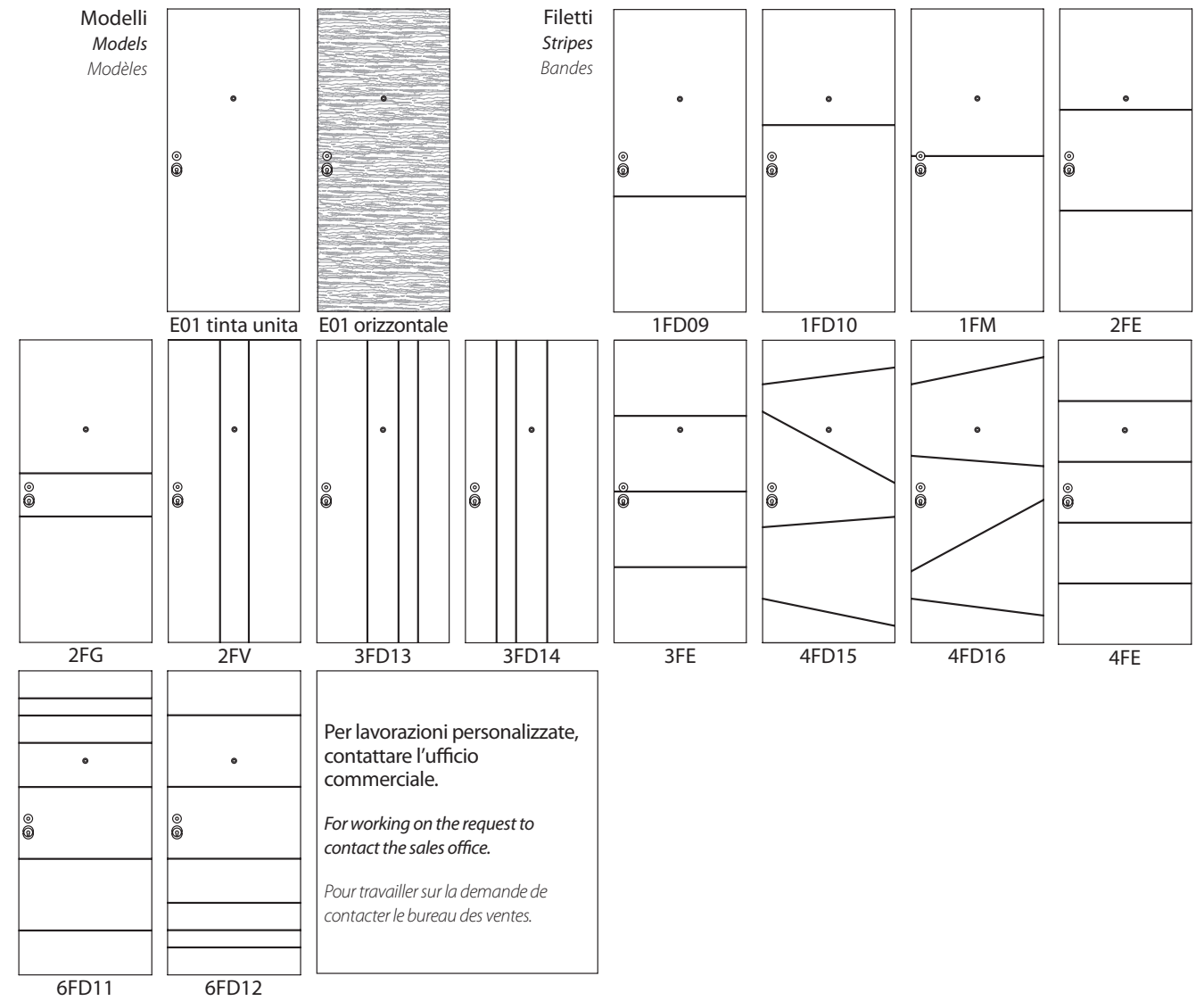
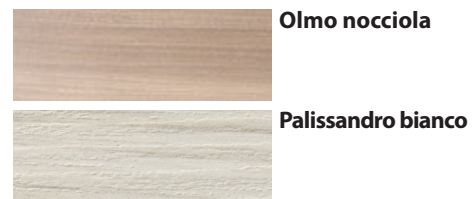

Sezione
Section
Section

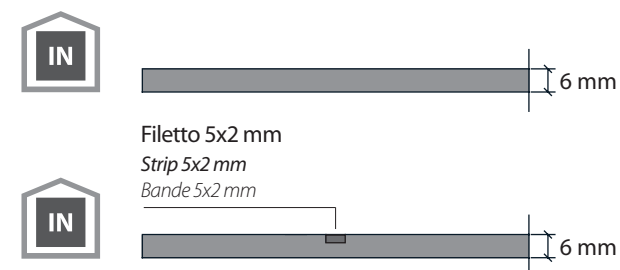



OTELLO

Il sapore unico del legno incontra l'estetica contemporanea delle venature orientate, delle incisioni, dei filetti e del colore. Laccature, essenze e finiture sono coordinabili con porte interne e battiscopa. È possibile inoltre scegliere tra pannelli con diverse prestazioni di resistenza agli agenti esterni.

The unique flavor of the wood meets the contemporary aesthetic of the oriented grain, the cuts, the threads and color. Lacquers, woods and finishes are coordinated with interior doors and baseboards. You can also choose between panels with different performance of resistance to external agents.

La saveur unique du bois répond à l'esthétique contemporaine de grains orientés, les coupes, les fils et la couleur. Laques, les bois et les finitions sont coordonnées avec les portes intérieures et les plinthes. Vous pouvez également choisir entre les panneaux avec des performances différentes de la résistance aux agents extérieurs.



Essenze e Finiture*
Essences and finishes*
Essences et finitions*

	Mogano Tinto Chiaro <i>Mahogany Dyed Clear</i> <i>Acajou Teinté Clair</i>		Rovere Tabacco <i>Oak Tobacco</i> <i>Chêne Tabac</i>
	Mogano Tinto Medio <i>Mahogany Dyed Medium</i> <i>Acajou Teinté Moyenne</i>		Castagno Tinto Medio <i>Chestnut Dyed Medium</i> <i>Châtaigne Teinté Moyenne</i>
	Tanganica Tinto Medio <i>Tanganika Dyed Medium</i> <i>Tanganyika Teinté Moyenne</i>		Castagno Tinto Scuro <i>Walnut Dyed Dark</i> <i>Châtaigne Teinté Sombre</i>
	Tanganica Tonalizzato Naturale <i>Tanganyika Natural Colour-enhancing</i> <i>Tanganyika teint naturel</i>		Castagno Laccato a Poro aperto RAL <i>Open Pore Lacquered RAL Chestnut</i> <i>Châtaigne Laqué Pore ouvert RAL</i>
	Tanganica Tinto Chiaro <i>Tanganyika Dyed Clear</i> <i>Tanganyika Teinté Clair</i>		Castagno Sabbiato Laccato RAL <i>Chestnut sandblasted lacquered RAL</i> <i>Châtaigne sablé laqué RAL</i>
	Tanganica Tinto Ciliegio <i>Tanganika Dyed Cherry</i> <i>Tanganyika Teinté Cerise</i>		Castagno Decò L1 <i>Decò L1 Chestnut</i> <i>Châtaigne Decò L1</i>
	Rovere Naturale <i>Natural Oak</i> <i>Chêne Naturel</i>		Castagno Decò L2 <i>Decò L2 Chestnut</i> <i>Châtaigne Decò L2</i>
	Rovere Tinto Miele <i>Oak Dyed Honey</i> <i>Chêne Teinté Miel</i>		Noce Nazionale Tinto Medio <i>Italian Walnut Dyed Medium</i> <i>Noyer Italien Teinté Moyenne</i>



Laccato colori standard
Lacquered standard colors
Couleurs standard laqués

RAL (opzionale)
RAL (optional)
RAL (sur demande)

RAL 9003	RAL 9010	RAL 9001	RAL 1013	RAL 9002
RAL 7035	RAL 7044	RAL 7005	RAL 3004	
RAL 6021	RAL 6005	RAL 5001	RAL 8019	
RAL	RAL	RAL	RAL	
	Finitura opaca (di serie) <i>Matte finish (standard)</i> <i>Finition mate (standard)</i>	Finitura lucida (opzionale) <i>Glossy finish (optional)</i> <i>Finition brillante (sur demande)</i>	Finitura goffrato fine (opzionale) <i>Finish embossed (optional)</i> <i>Terminer en relief (sur demande)</i>	

Modelli
Models
Modèles

251 laccato	251* Incisione 6x2 mm <i>Engraving 6x2 mm</i> <i>Gravure 6x2 mm</i>	278	279	280	283	284	288
290	285 inciso	286 inciso	287 inciso	1FD09	1FD10		
1FM	2FE	2FG	2FV	3FD13	3FD14	3FE	4FD15
			<p>Per lavorazioni personalizzate, contattare l'ufficio commerciale.</p> <p><i>For working on the request to contact the sales office.</i></p> <p><i>Pour travailler sur la demande de contacter le bureau des ventes.</i></p>				
4FE	6FD11	6FD12					



	6 mm
	12 mm
	*14 mm
	*18 mm



SEGNO



SEGNO



Leggiadra eleganza

Un gesto gentile ma deciso che esalta le preziose superfici laccate: una delicata incisione che si distingue per le eleganti estremità rese appuntite dalla particolare tecnica di lavorazione computerizzata rifinita a mano. Coordinabile con porte interne, imbotti e battiscopa.

Graceful elegance

A gentle but decisive gesture that enhances the precious lacquered surfaces: a delicate incision that stands out for the elegant ends made pointed by the particular hand-finished computerized processing technique. Coordinates with internal doors, jambs and baseboards.

Élégance gracieuse

Un geste doux mais décisif qui met en valeur les précieuses surfaces laquées: une incision délicate qui se distingue par les extrémités élégantes rendues pointues par la technique de traitement informatisée particulière finie à la main. Coordonne avec portes internes, les montants et les plinthes.

Modelli
Models
Modèles

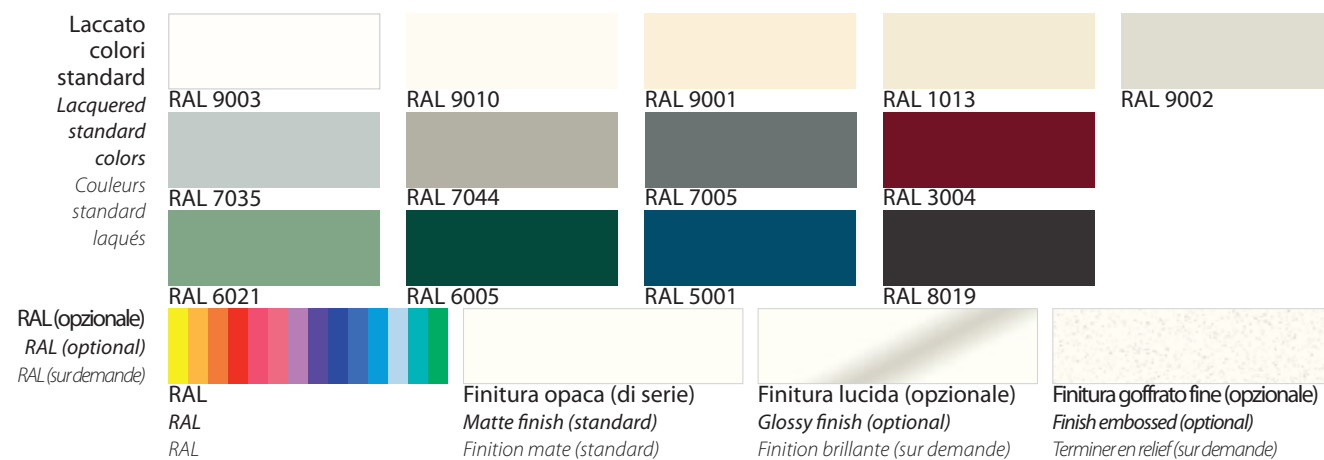
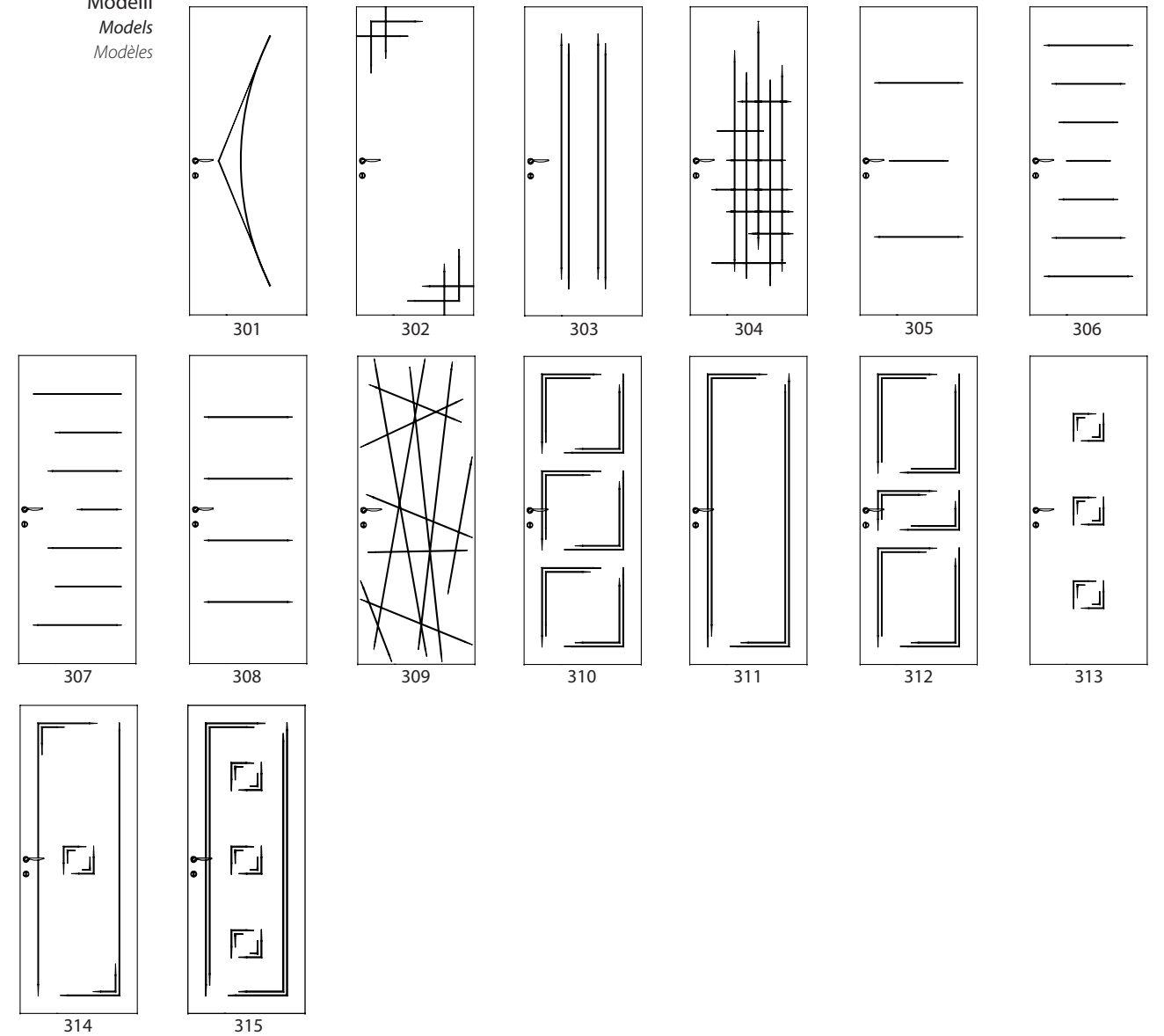

Sezione
Section
Section

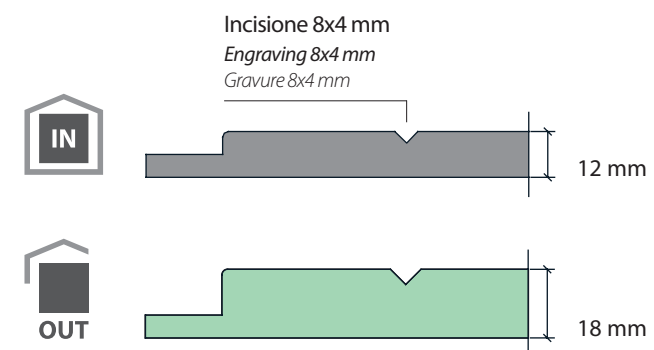

STILE



STILE



Modelli
Models
Modèles

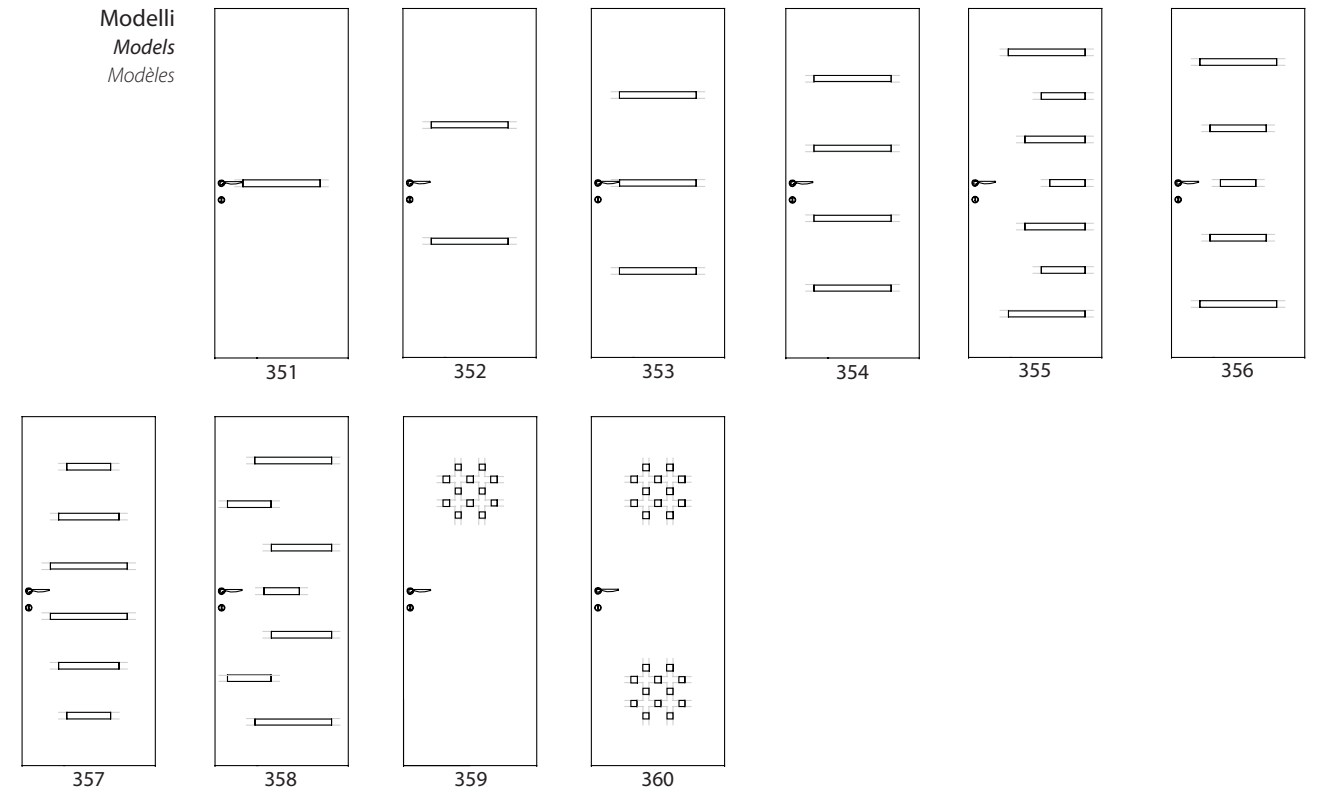

Giochi di luce

Il tema delle incisioni trova nella collezione STILE la sua massima espressione decorativa. La finitura laccata della porta si anima nel gioco di luci ed ombre generate dalla sofisticata lavorazione superficiale. Eleganza e innovazione si incontrano per regalare una porta di elevato valore estetico e funzionale, nata per arredare con gusto gli ambienti dell'abitare contemporaneo. Coordinabile con porte interne, imbotti e battiscopa.

Play of light

The theme of the engravings finds its maximum decorative expression in the STILE collection. The lacquered finish comes alive in the play of light and shadow generated by the sophisticated surface processing. Elegance and innovation come together to give a door of high aesthetic and functional value, created to furnish contemporary living environments with taste. Coordinates with internal doors, jambs and baseboards.

Jeu de lumière

Le thème des gravures trouve son expression décorative maximale dans la collection STILE. La finition laquée prend vie dans le jeu d'ombre et de lumière généré par le traitement de surface sophistiqué. Élégance et innovation se rencontrent pour donner une porte de haute valeur esthétique et fonctionnelle, créée pour meubler avec goût les espaces de vie contemporains. Coordonne avec portes internes, les montants et les plinthes.

Laccato colori standard Lacquered standard colors Couleurs standard laqués					
	RAL 9003	RAL 9010	RAL 9001	RAL 1013	RAL 9002
	RAL 7035	RAL 7044	RAL 7005	RAL 3004	
RAL (opzionale) RAL (optional) RAL (sur demande)					
	RAL 6021	RAL 6005	RAL 5001	RAL 8019	
	RAL	RAL	RAL	RAL	RAL
		Finitura opaca (di serie) Matte finish (standard) Finition mate (standard)	Finitura lucida (opzionale) Glossy finish (optional) Finition brillante (sur demande)	Finitura goffrato fine (opzionale) Finish embossed (optional) Terminer en relief (sur demande)	

Sezione
Section
Section

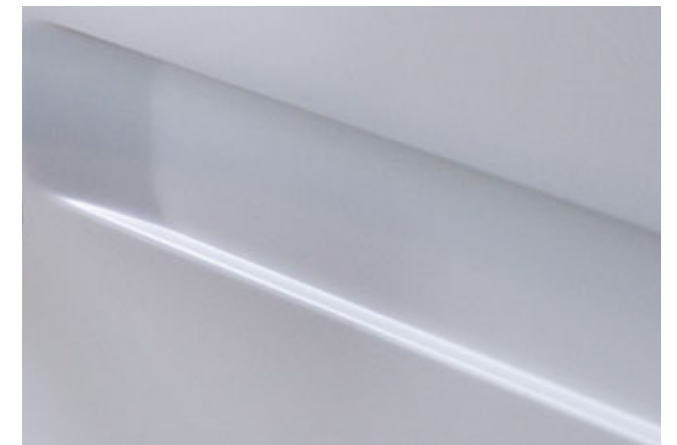
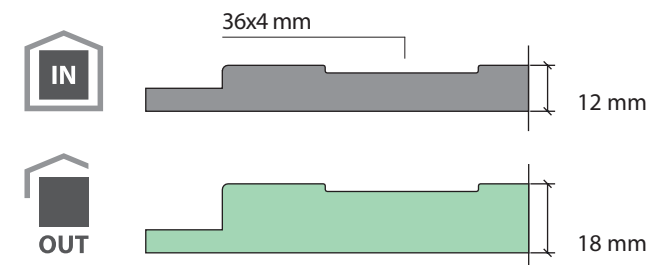

BUTTERFLY



BUTTERFLY



Il design elegante e raffinato delle incisioni pantografate al servizio di pannelli dalle elevate prestazioni costruttive. Disponibile in una vasta gamma di laccature RAL ed essenze legno, anche coordinati con porte interne. Scegli il materiale costruttivo più idoneo alla posizione del portone.

The elegant and refined design of the pantograph engravings in the service of high-performance building panels. Available in a wide range of RAL lacquers and wood types, also coordinated with interior doors. Choose the most suitable building material to the door position.

Le design élégant et raffiné des gravures de pantographes en service de panneaux de construction à haute performance. Disponible dans une large gamme de laques RAL et les types de bois, également coordonné avec les portes intérieures. Choisir le matériau de construction le plus adapté à la position de la porte.

Essenze e Finiture
Essences and finishes
Essences et finitions



Okumè Tinto Chiaro
Okumè Dyed Clear
Okumè Teinté Clair



Okumè Tinto Ciliegio
Okumè Dyed Cherry
Okumè Teinté Cerise



Okumè Tinto Medio
Okumè Dyed Medium
Okumè Teinté Moyenne

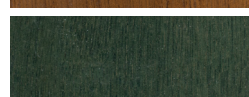

Okumè Tinto Verde
Okumè Dyed Green
Okumè Teinté Vert

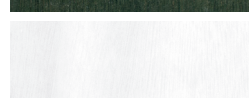

Tanganica Laccato RAL
Tanganica lacquered RAL
Tanganica laqué RAL



Yellow Pine Tinto Chiaro
Yellow Pine Dyed Clear
Yellow Pine Teinté Clair



Yellow Pine Tinto Medio
Yellow Pine Dyed Medium
Yellow Pine Teinté Moyenne



Yellow Pine Tinto Verde
Yellow Pine Dyed Green
Yellow Pine Teinté Vert

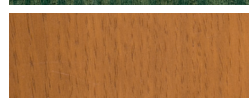

Rovere Tinto Miele
Oak Dyed Honey
Chêne Teinté Miel

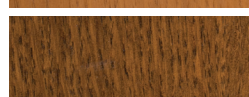

Rovere Tinto Medio
Oak Dyed Medium
Chêne Teinté Moyenne



Frassino Tinto Medio
Ash Dyed Medium
Frêne Teinté Moyenne



Frassino Laccato Poro aperto RAL
Ash lacquered open pore RAL
Frêne laqué à pores ouverts RAL

Laccato colori standard
Lacquered standard colors
Couleurs standard laqués

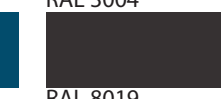
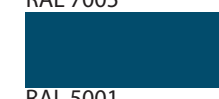
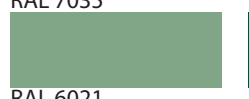
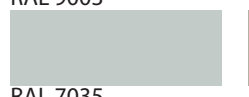
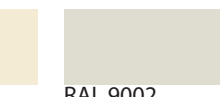
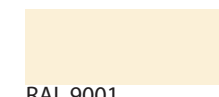
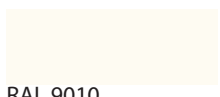

RAL (opzionale)
RAL (optional)
RAL (sur demande)

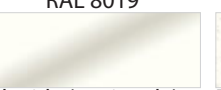
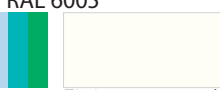

Finitura opaca (di serie)
Matte finish (standard)
Finition mate (standard)

Finitura lucida (opzionale)
Glossy finish (optional)
Finition brillante (sur demande)

Finitura goffrato fine (opzionale)
Finish embossed (optional)
Terminer en relief (sur demande)

Modelli
Models
Modèles

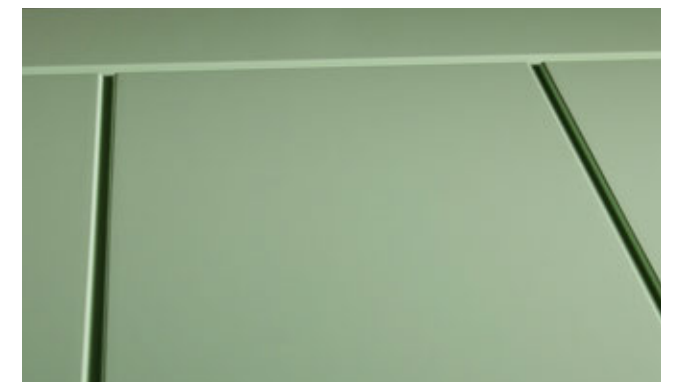
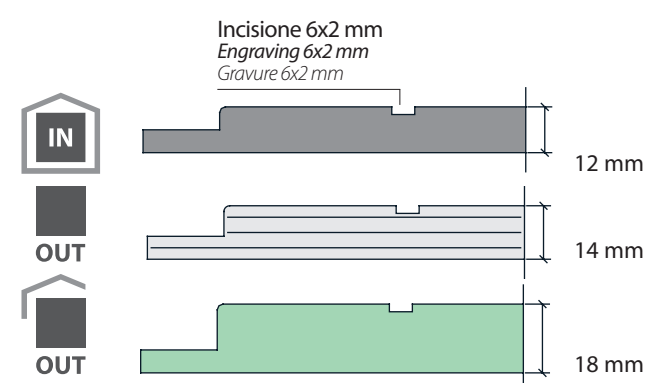
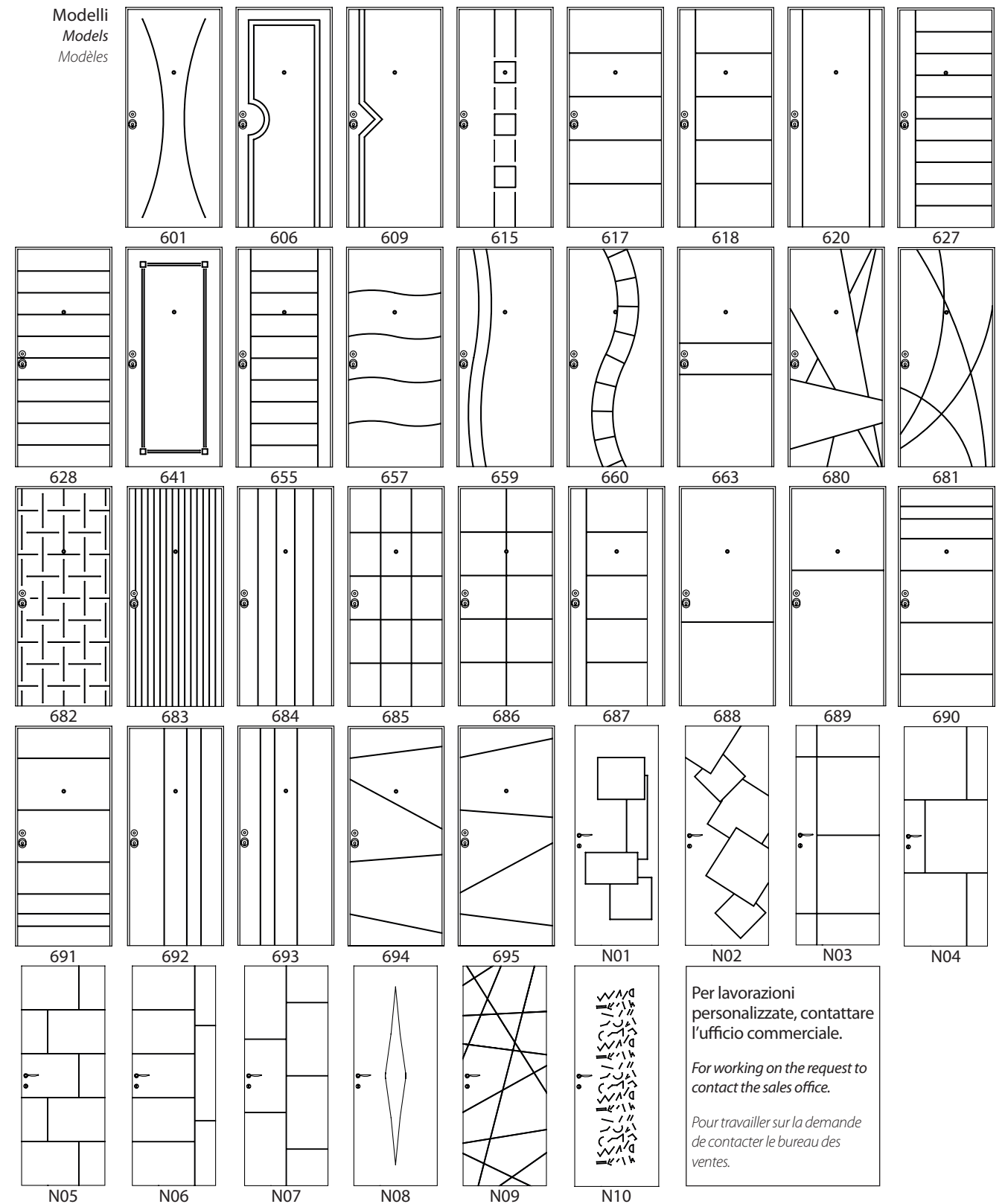

BUTTERFLY "V"



BUTTERFLY "V"



Un disegno contemporaneo e discreto dove l'incisione a "V" è valorizzata da laccature opache, lucide o testurizzate in tutti i colori RAL, perfettamente coordinabile con porte interne e battiscopa.

A contemporary design and discreet where the incision "V" is enhanced by matt lacquered shiny or textured in all RAL colors, perfectly coordinated with interior doors and baseboards.

Un design contemporain et discret où l'incision "V" est renforcée par laqué mat brillantes ou texturées, dans toutes les couleurs RAL, parfaitement coordonné avec les portes intérieures et les plinthes.

Laccato colori standard Lacquered standard colors Couleurs standard laqués					
	RAL 9003	RAL 9010	RAL 9001	RAL 1013	RAL 9002
	RAL 7035	RAL 7044	RAL 7005	RAL 3004	
RAL (opzionale) RAL (optional) RAL (sur demande)					
	RAL 6021	RAL 6005	RAL 5001	RAL 8019	
	RAL	RAL	RAL	RAL	
		Finitura opaca (di serie) Matte finish (standard) Finition mate (standard)	Finitura lucida (opzionale) Glossy finish (optional) Finition brillante (sur demande)	Finitura goffrato fine (opzionale) Finish embossed (optional) Terminer en relief (sur demande)	

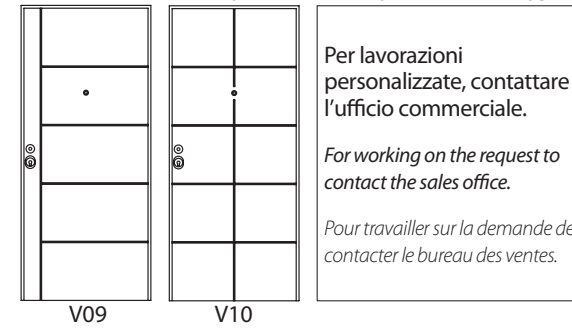
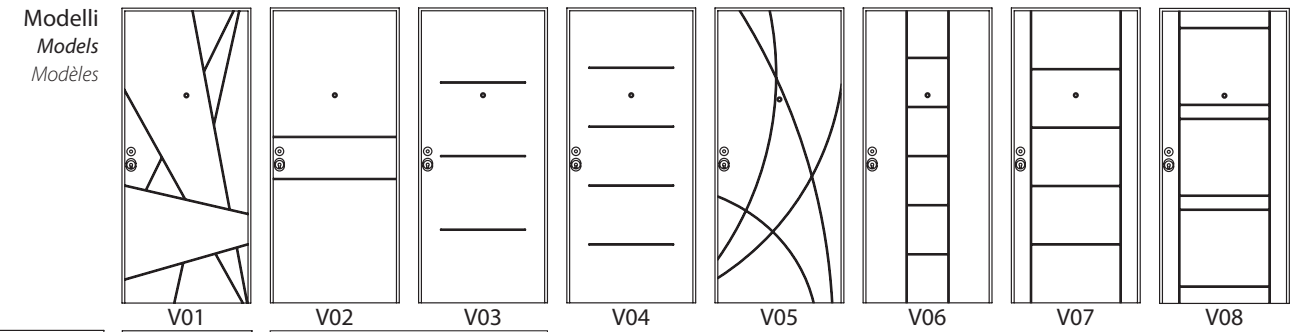

Fuori misura
Per mantenere lo stesso aspetto e la stessa proporzione del design anche nel caso di portoni con misure maggiori o con proporzioni diverse, il nostro ufficio tecnico sviluppa uno schema di suddivisione e di incisione progettato ad hoc.

Out of size
To maintain the same look and the same proportion of the design even for doors with more or different proportions measures, our technical department develops a subdivision scheme and engraving designed ad hoc.

Des mesures supplémentaires
Pour maintenir le même aspect et la même proportion de la conception même pour les portes avec des proportions plus ou différentes mesures, notre département technique développe un schéma de subdivision et de gravure conçu ad hoc.

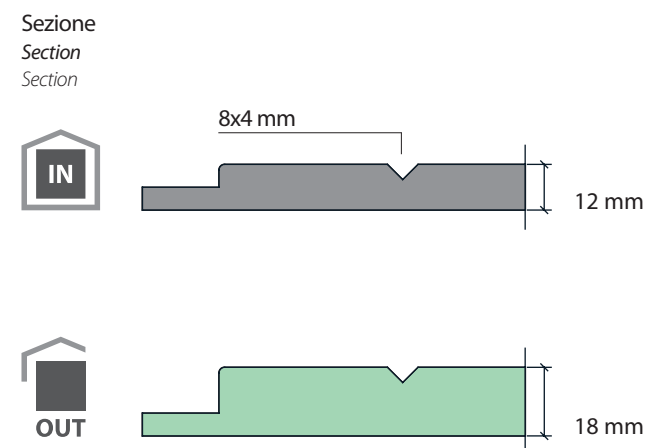



Disegni classici ed eleganti prendono vita nelle modanature pantografate con angoli arrotondati realizzate con assoluta precisione. Un prodotto ideale sia per finiture effetto legno che per laccature RAL e in stile decò. Coordinabile con porte interne, imbotti e battiscopa.

Classic designs and elegant come alive in pantografate moldings with rounded corners made with absolute precision. Ideal for wood effect finishes to RAL lacquering and art-deco. Coordinates with internal doors, jambs and baseboards.

Conceptions classiques et élégant prennent vie dans moulures pantografate avec des coins arrondis effectués avec une précision absolue. Idéal pour effet de finitions en bois RAL laquage et art-déco. Coordonne avec portes internes, les montants et les plinthes.

Essenze e Finiture Essences and finishes Essences et finitions		Okumè Tinto Chiaro <i>Okumè Dyed Clear</i> <i>Okumè Teinté Clair</i>		Yellow Pine Tinto Medio <i>Yellow Pine Dyed Medium</i> <i>Yellow Pine Teinté Moyenne</i>
		Okumè Tinto Ciliegio <i>Okumè Dyed Cherry</i> <i>Okumè Teinté Cerise</i>		Yellow Pine Tinto Verde <i>Yellow Pine Dyed Green</i> <i>Yellow Pine Teinté Vert</i>
		Okumè Tinto Medio <i>Okumè Dyed Medium</i> <i>Okumè Teinté Moyenne</i>		Rovere Tinto Miele <i>Oak Dyed Honey</i> <i>Chêne Teinté Miel</i>
		Okumè Tinto Verde <i>Okumè Dyed Green</i> <i>Okumè Teinté Vert</i>		Rovere Tinto Medio <i>Oak Dyed Medium</i> <i>Chêne Teinté Moyenne</i>
		Tanganica Laccato RAL <i>Tanganica lacquered RAL</i> <i>Tanganica laqué RAL</i>		Frassino Tinto Medio <i>Ash Dyed Medium</i> <i>Frêne Teinté Moyenne</i>
		Yellow Pine Tinto Chiaro <i>Yellow Pine Dyed Clear</i> <i>Yellow Pine Teinté Clair</i>		Frassino Laccato Poro aperto RAL <i>Ash lacquered open pore RAL</i> <i>Frêne laqué à pores ouverts RAL</i>

Laccato colori standard Lacquered standard colors Couleurs standard laqués					
RAL (opzionale) RAL (optional) RAL (sur demande)					
	Finitura opaca (di serie) <i>Matte finish (standard)</i> <i>Finition mate (standard)</i>	Finitura lucida (opzionale) <i>Glossy finish (optional)</i> <i>Finition brillante (sur demande)</i>	Finitura goffrato fine (opzionale) <i>Finish embossed (optional)</i> <i>Terminer en relief (sur demande)</i>		

Modelli
Models
Modèles

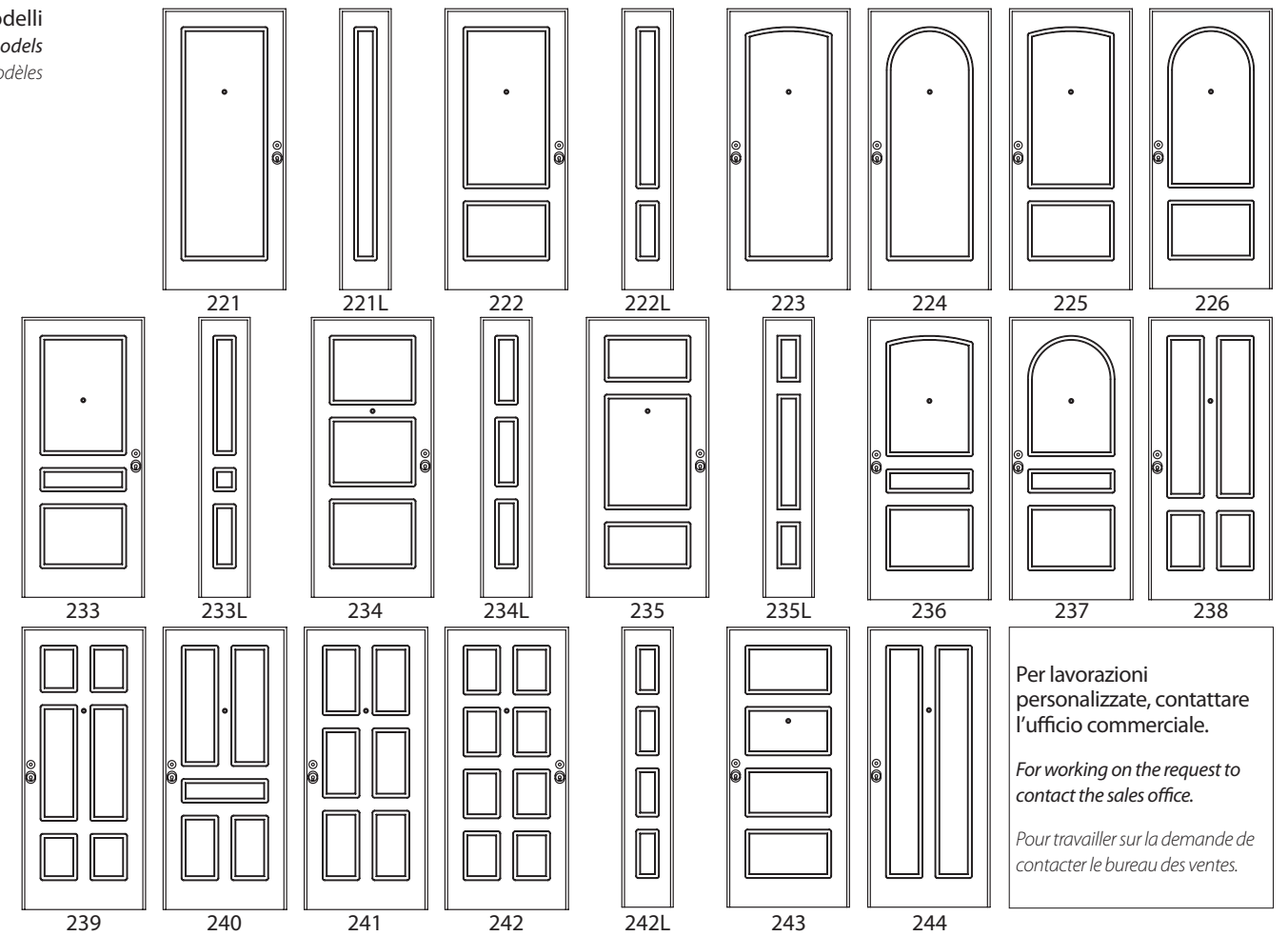

Per lavorazioni personalizzate, contattare l'ufficio commerciale.
For working on the request to contact the sales office.
Pour travailler sur la demande de contacter le bureau des ventes.

Fuori misura
Per mantenere lo stesso aspetto e la stessa proporzione del design anche nel caso di portoni con misure maggiori o con proporzioni diverse, il nostro ufficio tecnico sviluppa uno schema di suddivisione progettato ad hoc.

Out of size
To maintain the same look and the same proportion of the design even for doors with more or different proportions measures, our technical department develops a subdivision scheme designed ad hoc.

Des mesures supplémentaires
Pour maintenir le même aspect et la même proportion de la conception même pour les portes avec des proportions plus ou différentes mesures, notre département technique développe un schéma de subdivision conçu ad hoc.

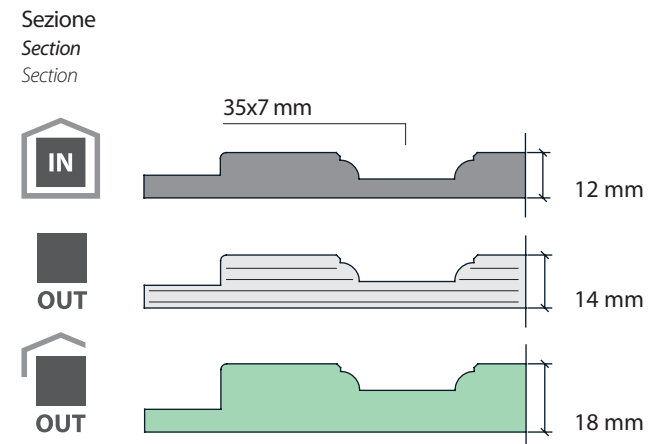

TOSCA "M"



TOSCA "M"



Il classico e il moderno si incontrano per un design contemporaneo e ricercato. Le linee realizzate con incisione di alta precisione, a base quadrata, definiscono un nuovo modo di disegnare la porta, essenziale e decorativo al tempo stesso. Coordinabile anche con porte interne e battiscopa.

The classical and the modern are meeting for a contemporary and sophisticated design. The classic design is made with high precision engraving with a square base: together define a new way of drawing the door, essential and decorative at the same time. Coordinates with internal doors and baseboards.

Le classique et le moderne se rencontrent pour un design contemporain et sophistiqué. Le design classique est fait avec gravure de haute précision avec une base carrée: définissent ensemble une nouvelle façon de tirer la porte, essentielle et décoratif dans le même temps. Coordonne avec portes internes les montants et les plinthes.

Laccato colori standard Lacquered standard colors Couleurs standard laqués					
	RAL 9003	RAL 9010	RAL 9001	RAL 1013	RAL 9002
	RAL 7035	RAL 7044	RAL 7005	RAL 3004	
RAL (opzionale) RAL (optional) RAL (sur demande)					
	RAL 6021	RAL 6005	RAL 5001	RAL 8019	
	RAL	RAL	RAL	RAL	RAL
		Finitura opaca (di serie) Matte finish (standard) Finition mate (standard)	Finitura lucida (opzionale) Glossy finish (optional) Finition brillante (sur demande)	Finitura goffrato fine (opzionale) Finish embossed (optional) Terminer en relief (sur demande)	

Modelli
Models
Modèles

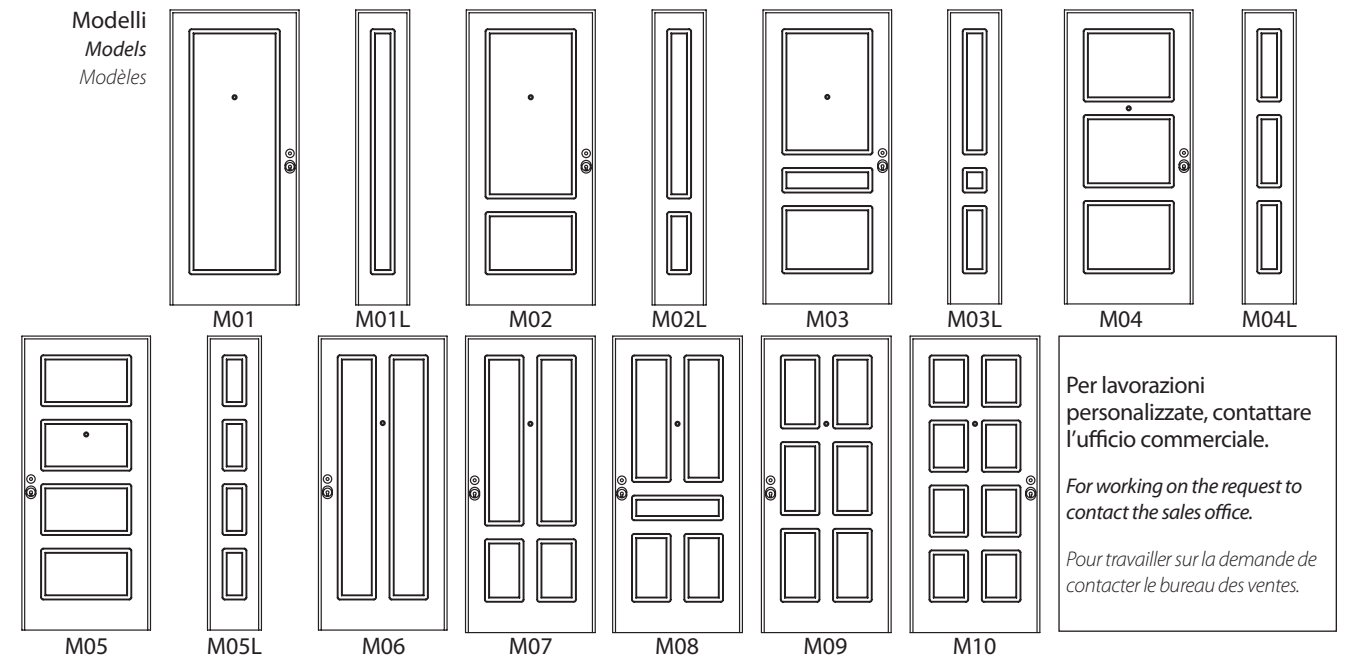

Fuori misura
Per mantenere lo stesso aspetto e la stessa proporzione del design anche nel caso di portoni con misure maggiori o con proporzioni diverse, il nostro ufficio tecnico sviluppa uno schema di suddivisione progettato ad hoc.

Out of size
To maintain the same look and the same proportion of the design even for doors with more or different proportions measures, our technical department develops a subdivision scheme designed ad hoc.

Des mesures supplémentaires
Pour maintenir le même aspect et la même proportion de la conception même pour les portes avec des proportions plus ou différentes mesures, notre département technique développe un schéma de subdivision conçu ad hoc.

Sezione
Section
Section

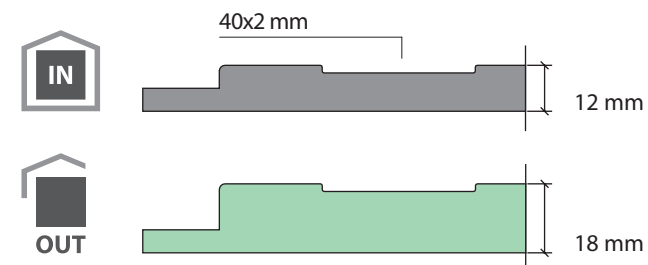

TURANDOT



TURANDOT



Le ricche modanature a sbalzo rievocano un gusto classico sobrio in grado di arricchire sia gli ambienti in stile che quelli più contemporanei, disponibile in tutti i colori RAL anche coordinabili con porte interne, in una vasta gamma di modelli anche con parti vetrate.

The rich embossed moldings evoke an understated classic taste that enrich both in a style that more contemporary ones, available in all RAL colors also coordinated with interior doors, in a wide range of models also with glazed parts.

Les riches moulures en relief évoquent un goût classique sobre qui enrichissent à la fois dans un style qui les plus contemporains, disponibles dans toutes les couleurs RAL également coordonnées avec les portes intérieures, dans une large gamme de modèles aussi de parties vitrées.

Modelli
Models
Modèles

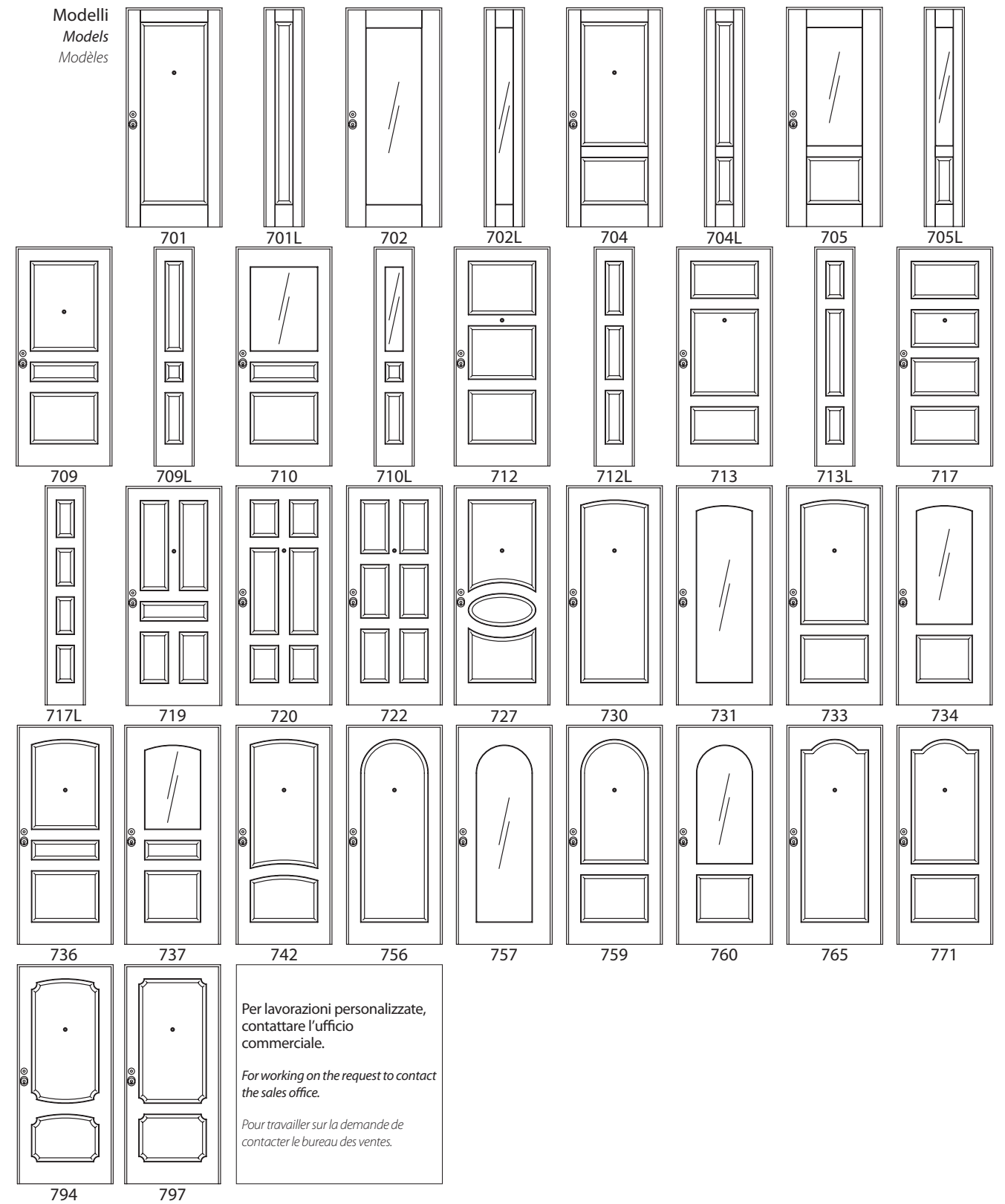

Per lavorazioni personalizzate, contattare l'ufficio commerciale.
For working on the request to contact the sales office.
Pour travailler sur la demande de contacter le bureau des ventes.

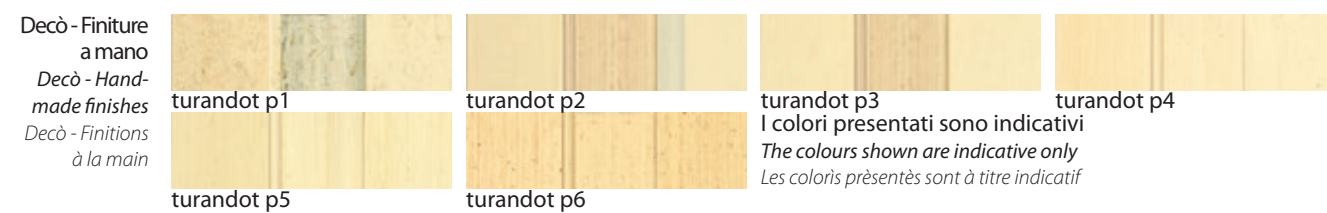
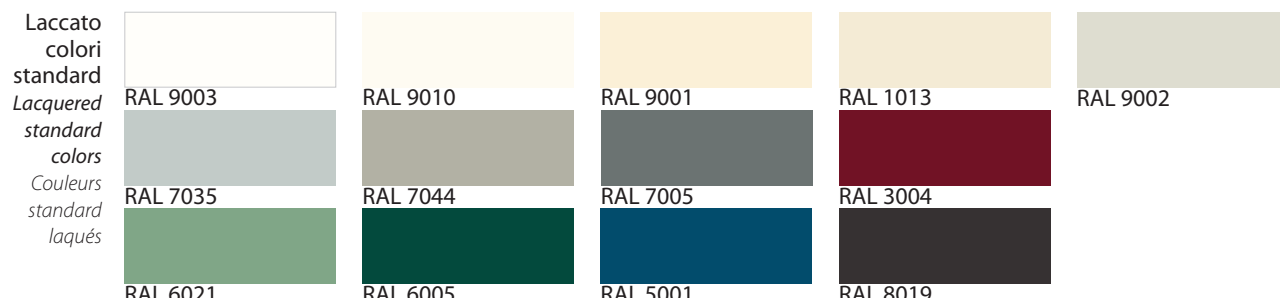

Sezione
Section
Section

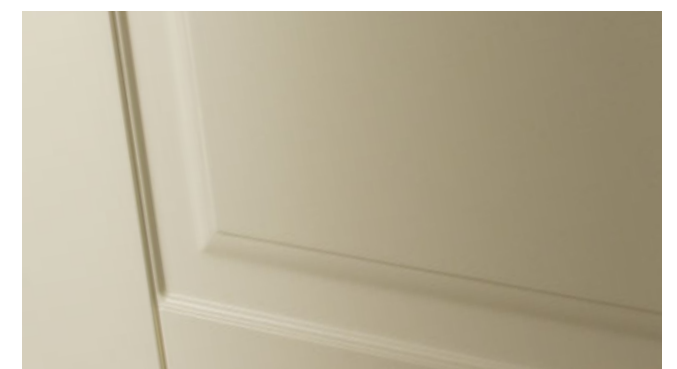
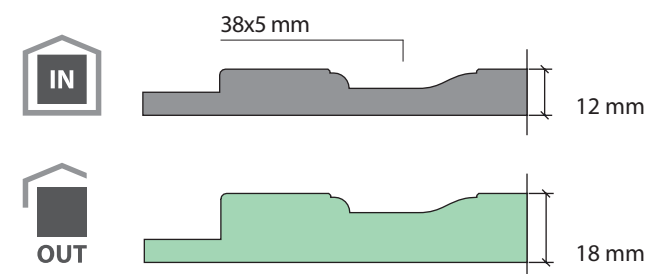

DUAL - Modern



DUAL - Modern



MODERN, l'alternanza tra la trama del legno e la purezza della laccatura, regolata da un gioco geometrico di linee incise, consente di creare opere destinate ad arricchire gli ambienti del vivere contemporaneo. Coordinabile con porte interne, imbotti e battiscopa.

MODERN, the alternation between the texture of the wood and the purity of the lacquering regulated by a geometric play of incised lines, allows the creation of works destined to enrich the environments of contemporary living. Coordinates with internal doors, jambs and baseboards.

MODERN, l'alternance entre la texture du bois et la pureté du laquage régulée par un jeu géométrique de lignes incisées, permet la création d'œuvres destinées à enrichir les environnements de la vie contemporaine. Coordonne avec portes internes, les montants et les plinthes.

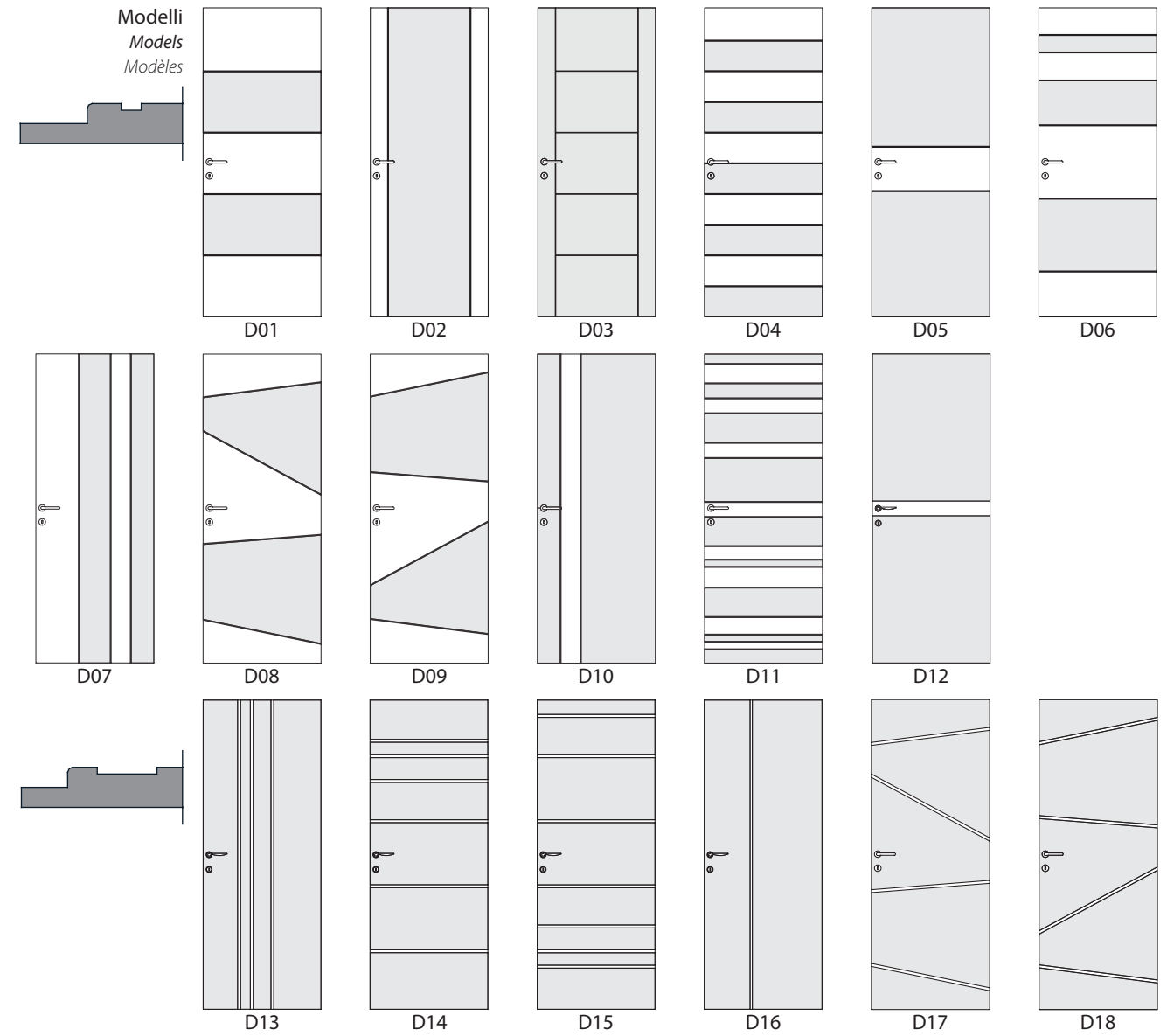

Laccato colori standard Lacquered standard colors Couleurs standard laqués					
	RAL 9003	RAL 9010	RAL 9001	RAL 1013	RAL 9002
	RAL 7035	RAL 7044	RAL 7005	RAL 3004	
RAL (opzionale) RAL (optional) RAL (sur demande)					
	RAL 6021	RAL 6005	RAL 5001	RAL 8019	
	Finitura opaca (di serie) Matte finish (standard) Finition mate (standard)	Finitura lucida (opzionale) Glossy finish (optional) Finition brillante (sur demande)	Finitura goffrato fine (opzionale) Finish embossed (optional) Terminer en relief (sur demande)		

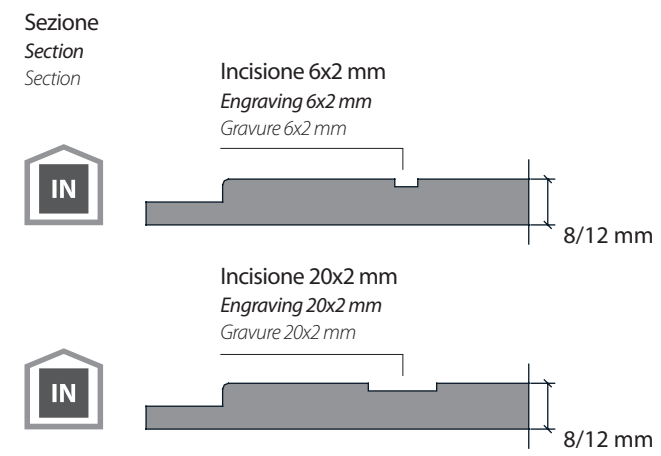

DUAL - Vintage



Il gioco delle superfici laccate e in essenza obbedisce alle geometrie arrotondate che richiamano la grafica degli anni 70 reinterpretate in chiave contemporanea per una serie originale e ricercata. Coordinabile con porte interne, imbotti e battiscopa.

The play of lacquered surfaces and in essence obeys the rounded geometries that recall the graphics of the 70s reinterpreted in a contemporary key for an original and refined series. Coordinates with internal doors, jambs and baseboards.

Le jeu des surfaces laquées obéit essentiellement à des géométries arrondies qui rappellent le graphisme des années 70 réinterprété dans une touche contemporaine pour une série originale et raffinée. Coordonne avec portes internes, les montants et les plinthes.

Laccato colori standard Lacquered standard colors Couleurs standard laqués					
	RAL 9003	RAL 9010	RAL 9001	RAL 1013	RAL 9002
	RAL 7035	RAL 7044	RAL 7005	RAL 3004	
RAL (opzionale) RAL (optional) RAL (sur demande)					
	RAL 6021	RAL 6005	RAL 5001	RAL 8019	
	RAL	RAL	RAL	RAL	
		Finitura opaca (di serie) Matte finish (standard) Finition mate (standard)	Finitura lucida (opzionale) Glossy finish (optional) Finition brillante (sur demande)	Finitura goffrato fine (opzionale) Finish embossed (optional) Terminer en relief (sur demande)	

Modelli
Models
Modèles

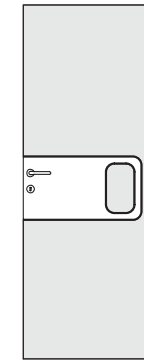

D25

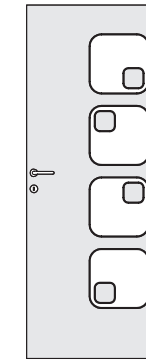

D26

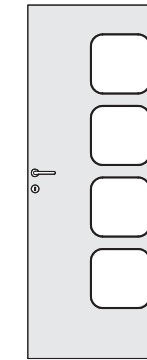

D27

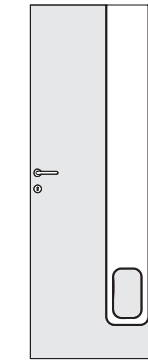

D28

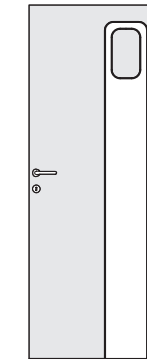

D29

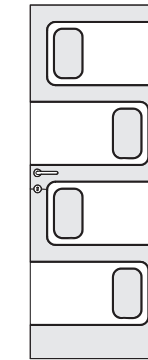

D30

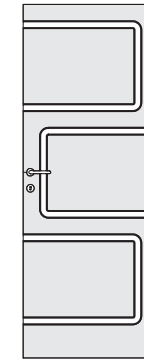

D31

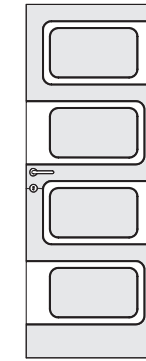

D32

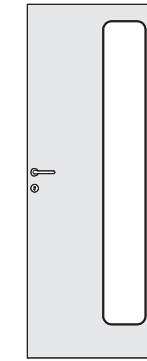

D33

Per lavorazioni personalizzate, contattare l'ufficio commerciale.
For working on the request to contact the sales office.
Pour travailler sur la demande de contacter le bureau des ventes.

Sezione
Section
Section

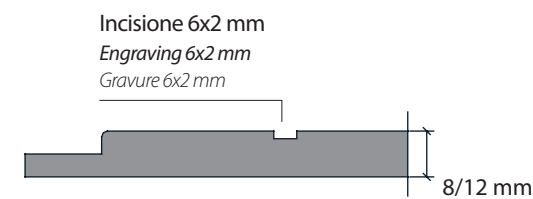

DUAL - Tosca



Il classico e il moderno si incontrano per un design contemporaneo e ricercato. Le linee realizzate con incisione di alta precisione, a base quadrata, definiscono un nuovo modo di disegnare la porta, essenziale e decorativo al tempo stesso. TOSCA è la porta ideale per piccoli e grandi progetti. Coordinabile con porte interne, imbotti e battiscopa.

The classic and the modern meet for a contemporary and sophisticated design. The lines made with high-precision engraving, with a square base, define a new way of drawing the door, essential and decorative at the same time. TOSCA is the ideal port for small and large projects. Coordinates with internal doors, jamba and baseboards.

Le classique et la rencontre moderne pour un design contemporain et sophistiqué. Les lignes faites avec gravure de haute précision, avec une base carrée, définissent une nouvelle façon de dessiner la porte, essentielle et décoratif dans le même temps. TOSCA est le port idéal pour petits et grands projets. Coordonne avec portes internes, les montants et les plinthes.

Laccato colori standard Lacquered standard colors Couleurs standard laqués					
	RAL 9003	RAL 9010	RAL 9001	RAL 1013	RAL 9002
	RAL 7035	RAL 7044	RAL 7005	RAL 3004	
RAL (opzionale) RAL (optional) RAL (sur demande)					
	RAL 6021	RAL 6005	RAL 5001	RAL 8019	
	RAL	RAL	RAL	RAL	RAL
		Finitura opaca (di serie) Matte finish (standard) Finition mate (standard)	Finitura lucida (opzionale) Glossy finish (optional) Finition brillante (sur demande)	Finitura goffrato fine (opzionale) Finish embossed (optional) Terminer en relief (sur demande)	

Modelli "M"
Models "M"
Modèles "M"

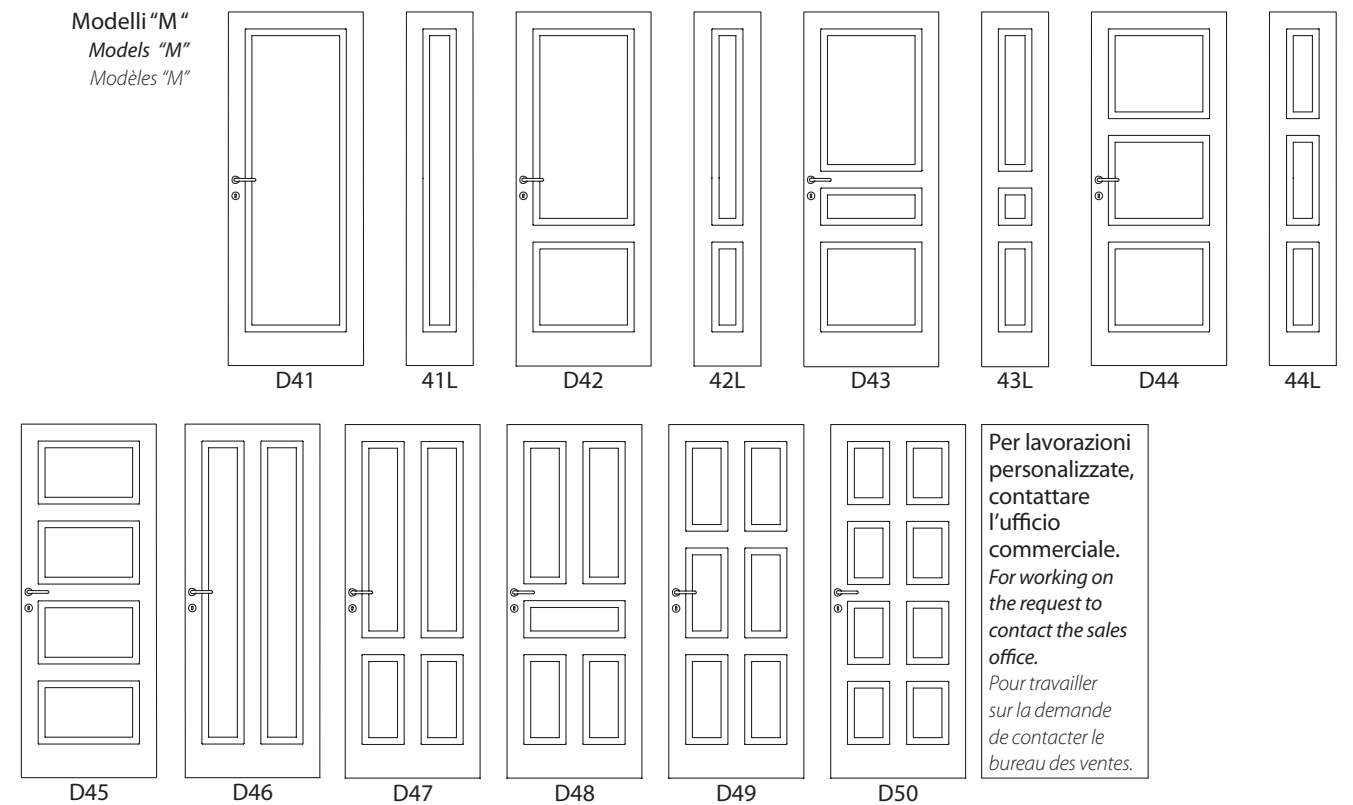

Sezione
Section
Section

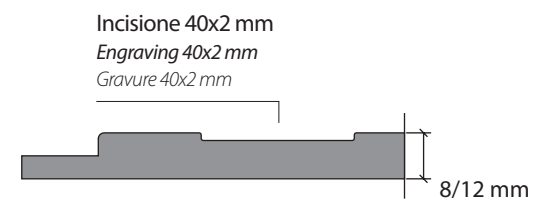

DUAL - Butterfly e Butterfly V



Le delicate incisioni e le incisioni a V che solcano la trama autentica del legno delle superfici laccate e sabbiato creano opere che uniscono eleganza e armonia per una serie senza tempo in grado di assecondare le esigenze del vivere contemporaneo. Coordinabile con porte interne, imbotti e battiscopa.

The delicate engravings and the V-shaped incisions that ply the authentic texture of the wood of the sanded lacquered surfaces create works that combine elegance and harmony for a timeless series that can satisfy the needs of contemporary living spaces. Coordinates with internal doors, jamb and baseboards.

Les gravures délicates et les incisions en forme de V qui imprègnent la texture authentique du bois des surfaces sablées créent des œuvres alliant élégance et harmonie pour une série intemporelle pouvant satisfaire les besoins de vie contemporains. Coordonne avec portes internes, les montants et les plinthes.

Laccato colori standard Lacquered standard colors Couleurs standard laqués					
	RAL 9003	RAL 9010	RAL 9001	RAL 1013	RAL 9002
	RAL 7035	RAL 7044	RAL 7005	RAL 3004	
	RAL 6021	RAL 6005	RAL 5001	RAL 8019	
RAL (opzionale) RAL (optional) RAL (sur demande)					
	RAL	RAL	RAL	RAL	RAL
		Finitura opaca (di serie) Matte finish (standard) Finition mate (standard)	Finitura lucida (opzionale) Glossy finish (optional) Finition brillante (sur demande)	Finitura goffrato fine (opzionale) Finish embossed (optional) Terminer en relief (sur demande)	

Modelli Butterfly
Models Butterfly
Modèles Butterfly

D56 D57 D58 D59 D60 D61
D62 D63 D64 D65 D66 D67 D68
D69 D70 D71

Modelli Butterfly V
Models Butterfly V
Modèles Butterfly V

D76 D77

D78 D79 D80 D81 D82

Per lavorazioni personalizzate, contattare l'ufficio commerciale.
For working on the request to contact the sales office.
Pour travailler sur la demande de contacter le bureau des ventes.

Sezione
Section
Section



Incisione Butterfly 6x2 mm
Engraving Butterfly 6x2 mm
Gravure Butterfly 6x2 mm



Incisione Butterfly V 8x4 mm
Engraving Butterfly V 8x4 mm
Gravure Butterfly V 8x4 mm



DUAL - Butterfly New



Le delicate incisioni che solcano la trama autentica del legno delle superfici laccate e sabbiate creano opere che uniscono eleganza e armonia per una serie senza tempo in grado di assecondare le esigenze del vivere contemporaneo. Coordinabile con porte interne, imbotti e battiscopa.

The delicate engravings incisions that ply the authentic texture of the wood of the sanded lacquered surfaces create works that combine elegance and harmony for a timeless series that can satisfy the needs of contemporary living spaces. Coordinates with internal doors, jams and baseboards.

Les gravures délicates qui imprègnent la texture authentique du bois des surfaces sablées créent des œuvres alliant élégance et harmonie pour une série intemporelle pouvant satisfaire les besoins de vie contemporains. Coordonne avec portes internes, les montants et les plinthes.

Modelli Butterfly New
Models Butterfly New
Modèles Butterfly New

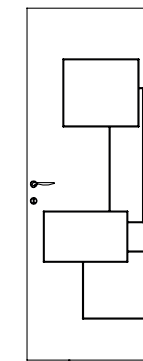

D120

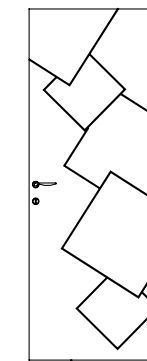

D121

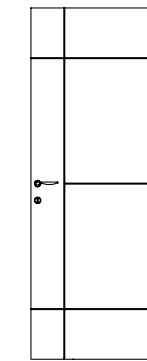

D122

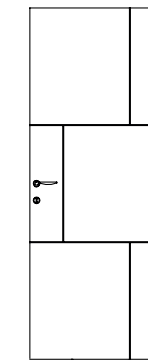

D123

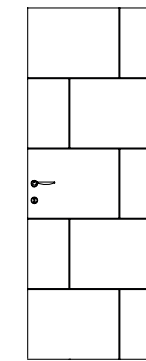

D124

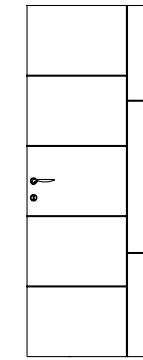

D125

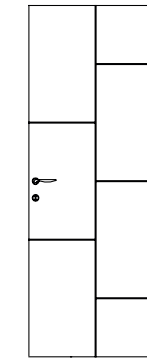

D126

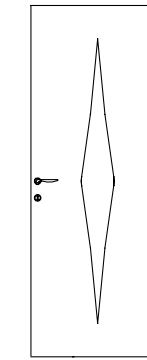

D127

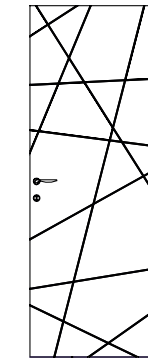

D128

Laccato colori standard Lacquered standard colors Couleurs standard laqués					
	RAL 9003	RAL 9010	RAL 9001	RAL 1013	RAL 9002
	RAL 7035	RAL 7044	RAL 7005	RAL 3004	
	RAL 6021	RAL 6005	RAL 5001	RAL 8019	
RAL (opzionale) RAL (optional) RAL (sur demande)					
	RAL	RAL	RAL	RAL	RAL
		Finitura opaca (di serie) Matte finish (standard) Finition mate (standard)	Finitura lucida (opzionale) Glossy finish (optional) Finition brillante (sur demande)	Finitura goffrato fine (opzionale) Finish embossed (optional) Terminer en relief (sur demande)	

Sezione
Section
Section



Incisione Butterfly 6x2 mm
Engraving Butterfly 6x2 mm
Gravure Butterfly 6x2 mm

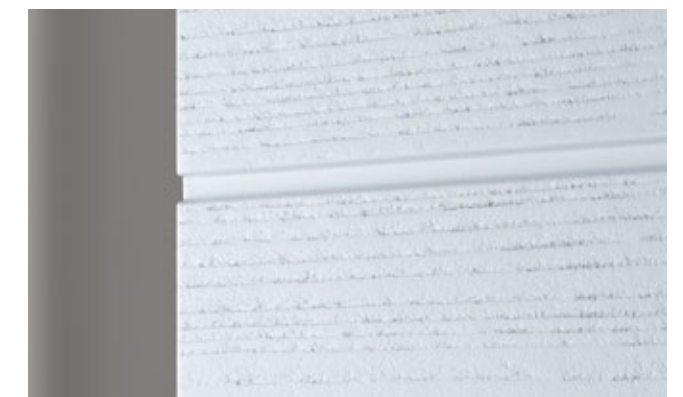

DUAL - SEGNO



Leggiadra eleganza

Un gesto gentile ma deciso che esalta le preziose superfici in essenza laccate e sabbiate a mano: una delicata incisione che si distingue per le eleganti estremità rese appuntite dalla particolare tecnica di lavorazione computerizzata rifinita a mano. Coordinabile con porte interne, imbotti e battiscopa

Graceful elegance

A gentle but decisive gesture that enhances the precious surfaces in lacquered and hand-sanded essence: a delicate engraving that stands out for the elegant ends made pointed by the particular hand-finished computerized processing technique. Coordinates with internal doors, jambs and baseboards.

Élégance gracieuse

Un geste doux mais décisif qui met en valeur les surfaces précieuses en essence laquées et poncées à la main : une gravure délicate qui se distingue par les extrémités élégantes rendues pointues par la technique particulière de traitement informatisé finie à la main. Coordonne avec portes internes, les montants et les plinthes.

Modelli
Models
Modèles

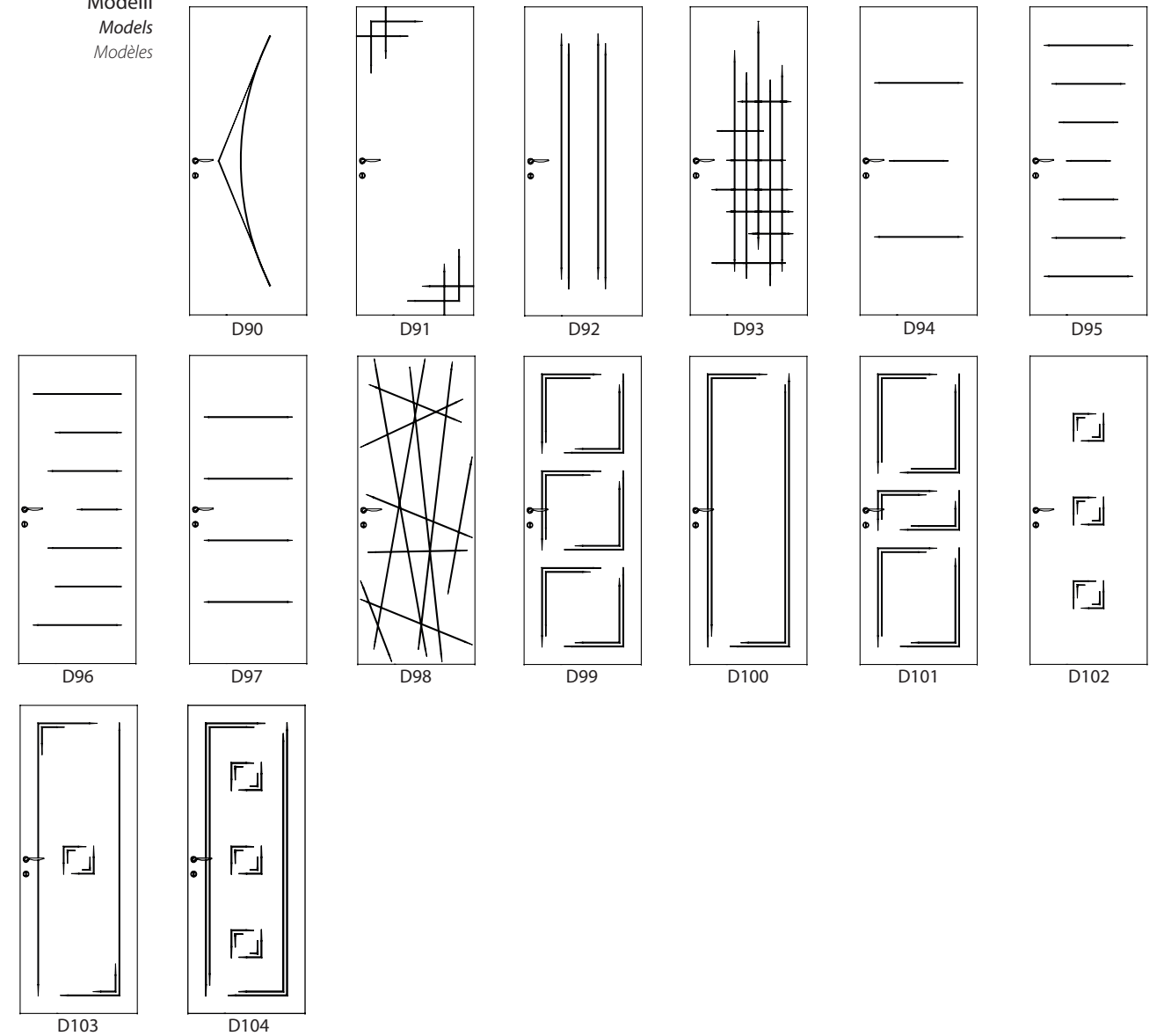

Laccato colori standard Lacquered standard colors Couleurs standard laqués					
	RAL 9003	RAL 9010	RAL 9001	RAL 1013	RAL 9002
	RAL 7035	RAL 7044	RAL 7005	RAL 3004	
RAL (opzionale) RAL (optional) RAL (sur demande)					
	RAL 6021	RAL 6005	RAL 5001	RAL 8019	
	RAL	RAL	RAL	RAL	RAL
		Finitura opaca (di serie) Matte finish (standard) Finition mate (standard)	Finitura lucida (opzionale) Glossy finish (optional) Finition brillante (sur demande)	Finitura goffrato fine (opzionale) Finish embossed (optional) Terminer en relief (sur demande)	

Sezione
Section
Section

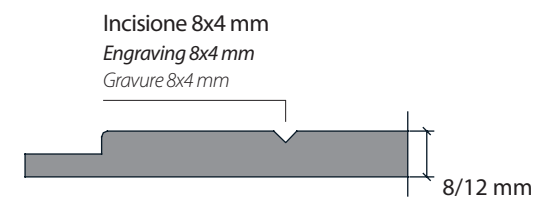

DUAL - STILE



Modelli
Models
Modèles

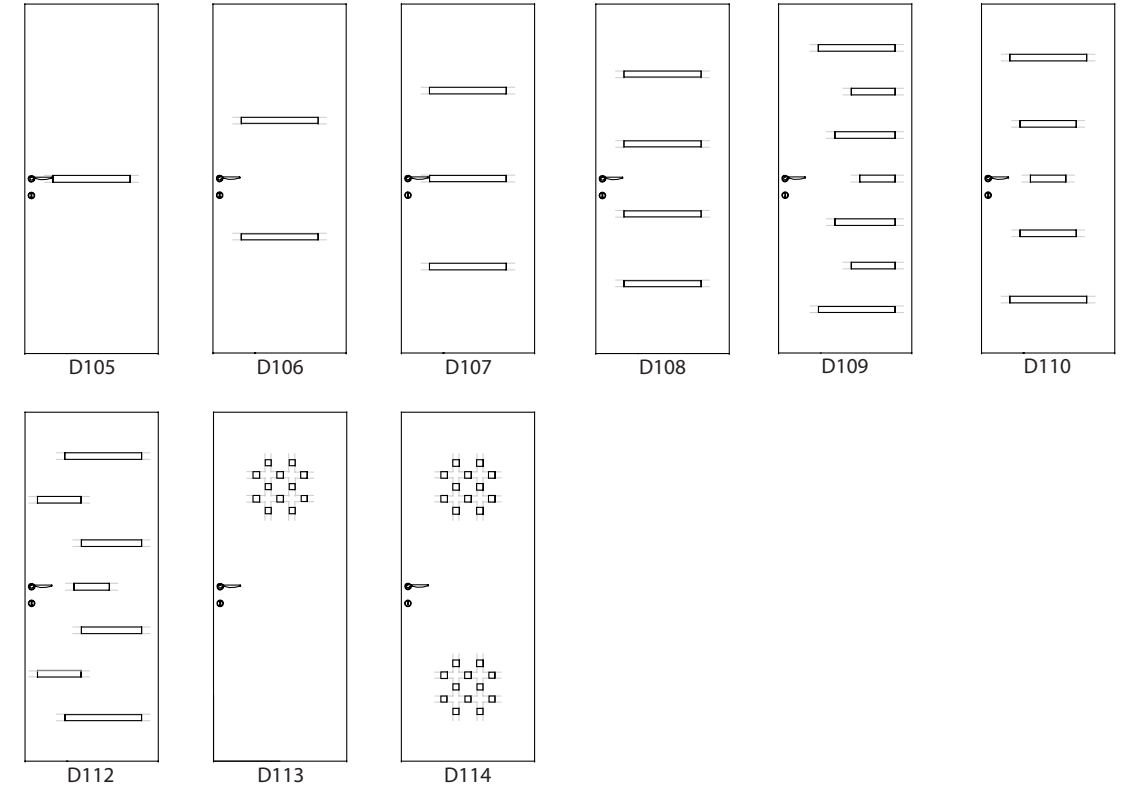

Giochi di luce

Il tema delle incisioni trova nella collezione STILE la sua massima espressione decorativa. La finitura laccata della porta si anima nel gioco di luci ed ombre generate dalla sofisticata lavorazione superficiale. Eleganza e innovazione si incontrano per regalare una porta di elevato valore estetico e funzionale, nata per arredare con gusto gli ambienti dell'abitare contemporaneo. Coordinabile con porte interne, imbotti e battiscopa.

Play of light

The theme of the engravings finds its maximum decorative expression in the STILE collection. The lacquered finish comes alive in the play of light and shadow generated by the sophisticated surface processing. Elegance and innovation come together to give a door of high aesthetic and functional value, created to furnish contemporary living environments with taste. Coordinates with internal doors, jambs and baseboards.

Jeu de lumière

Le thème des gravures trouve son expression décorative maximale dans la collection STILE. La finition laquée de la porte prend vie dans le jeu d'ombre et de lumière généré par le traitement de surface sophistiqué. Élégance et innovation se rencontrent pour donner une porte de haute valeur esthétique et fonctionnelle, créée pour meubler avec goût les espaces de vie contemporains. Coordonne avec portes internes, les montants et les plinthes.

Laccato colori standard Lacquered standard colors Couleurs standard laqués					
	RAL 9003	RAL 9010	RAL 9001	RAL 1013	RAL 9002
	RAL 7035	RAL 7044	RAL 7005	RAL 3004	
RAL (opzionale) RAL (optional) RAL (sur demande)					
	RAL 6021	RAL 6005	RAL 5001	RAL 8019	
	Finitura opaca (di serie) Matte finish (standard) Finition mate (standard)	Finitura lucida (opzionale) Glossy finish (optional) Finition brillante (sur demande)	Finitura goffrato fine (opzionale) Finish embossed (optional) Terminer en relief (sur demande)		

Sezione
Section
Section

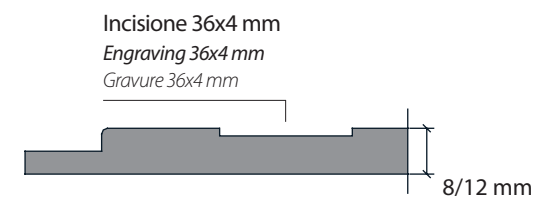



GRANDUCATO



Lo stile rustico toscano rivive nelle modanature in legno di GRANDUCATO, che grazie a un disegno classico e intramontabile conferisce alla tua casa un valore destinato a durare nel tempo e totalmente coordinato con porte interne, imbotti e battiscopa.

The Tuscan style lives on in the Granducato in wood moldings, which thanks to a classic and timeless design gives your home a value that will last over time and totally coordinated with interior doors, jambs and baseboards.

Le style toscan vit dans le Granducato de moulures de bois, qui, grâce à un design classique et intemporel donne à votre maison une valeur qui va durer dans le temps et totalement coordonnée avec portes intérieures, les montants et les plinthes.

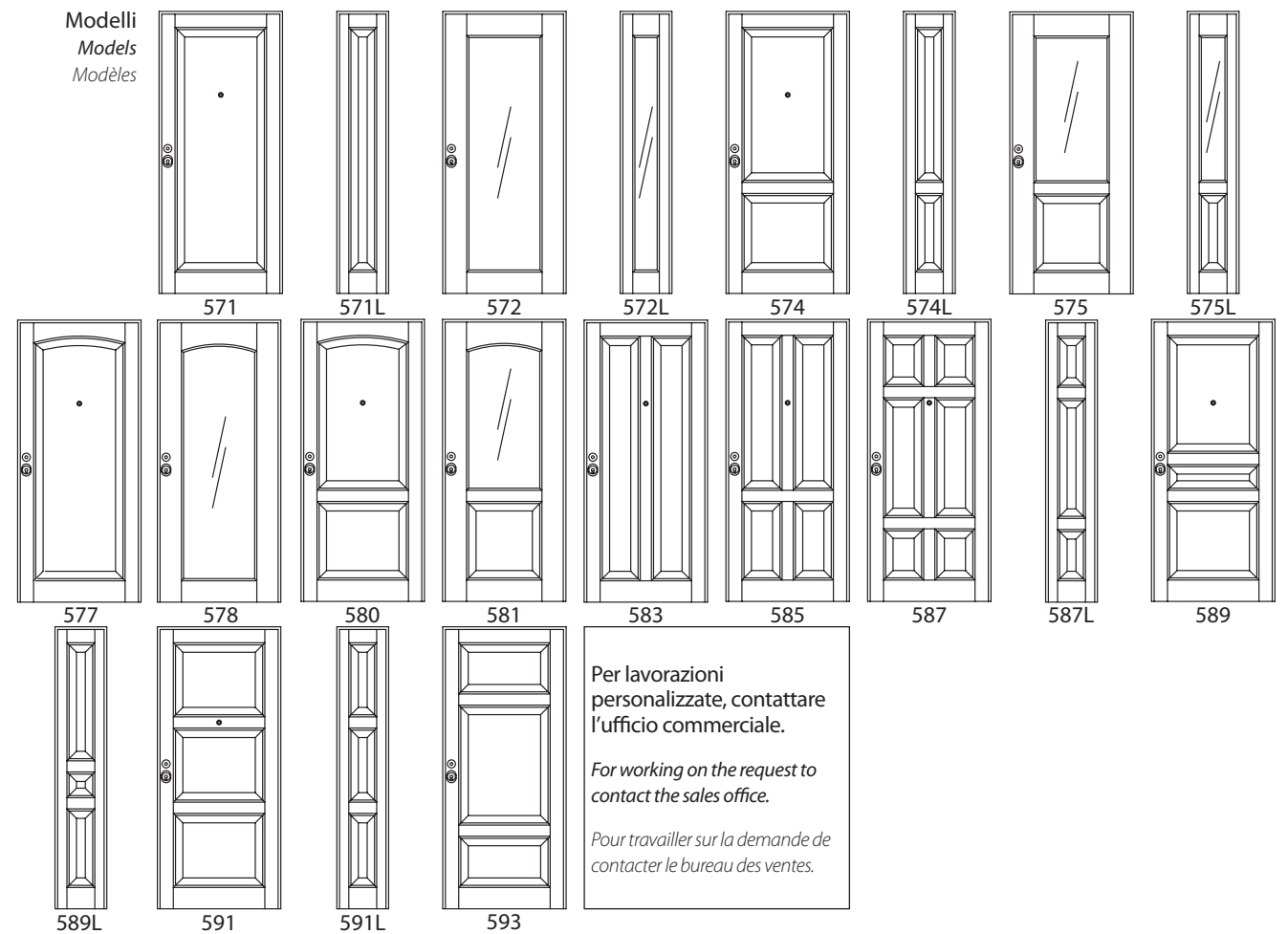

Per lavorazioni personalizzate, contattare l'ufficio commerciale.
 For working on the request to contact the sales office.
 Pour travailler sur la demande de contacter le bureau des ventes.

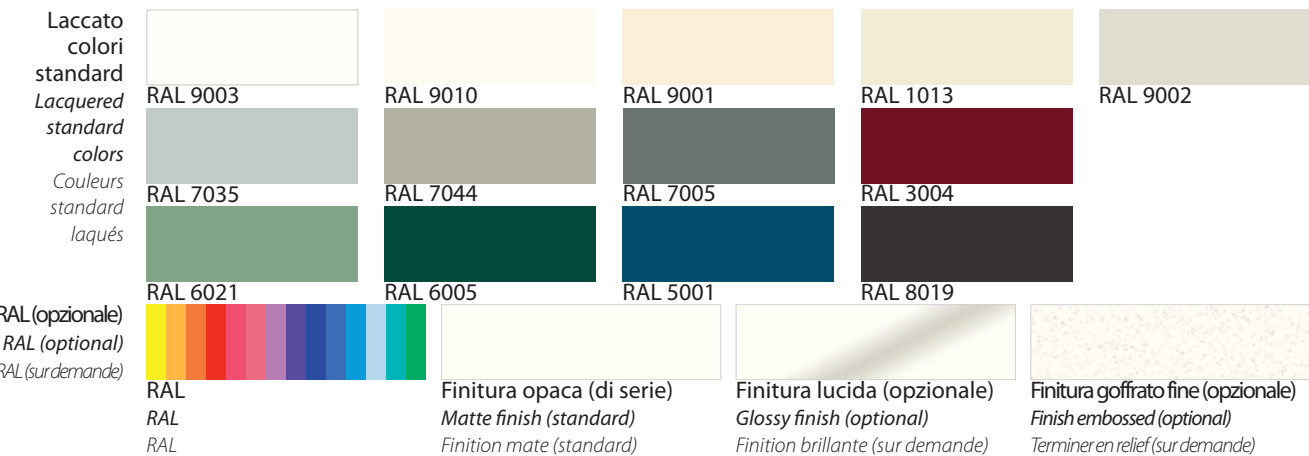

Fuori misura
 Per mantenere lo stesso aspetto e la stessa proporzione del design anche nel caso di portoni con misure maggiori o con proporzioni diverse, il nostro ufficio tecnico sviluppa uno schema di suddivisione progettato ad hoc.

Out of size
 To maintain the same look and the same proportion of the design even for doors with more or different proportions measures, our technical department develops a subdivision scheme designed ad hoc.

Des mesures supplémentaires
 Pour maintenir le même aspect et la même proportion de la conception même pour les portes avec des proportions plus ou différentes mesures, notre département technique développe un schéma de subdivision conçu ad hoc.

Sezione
 Section
 Section

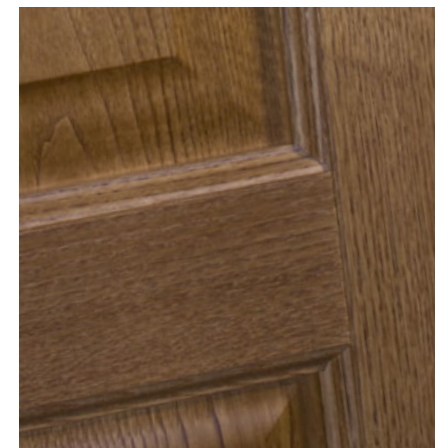



ATHENA



Imponente e signorile come la Dea della Sapienza, questa linea di pannelli di rivestimento dallo stile classico, disponibile anche con vetrate, è pensato per ambienti di prestigio sia in campagna che in città. Disponibile in numerose finiture effetto legno e in tutti i colori RAL, sia per interni che per esterni.

Imposing and stately as the Goddess of Wisdom, this line of classic-style paneling, also available with stained glass windows, is designed for prestigious environments both in the countryside and in cities. Available in different finishes and wood effect in all RAL colors, both indoors and outdoors.

Imposant et majestueux comme la déesse de la sagesse, cette ligne de boiserie de style classique, également disponible avec des vitraux, est conçue pour les environnements de prestige à la fois à la campagne et dans les villes. Disponible en différentes finitions et effet bois dans toute RAL color, à la fois intérieur et extérieur.

Essenze e Finiture Essences and finishes Essences et finitions		Okumè Tinto Chiaro Okumè Dyed Clear Okumè Teinté Clair		Yellow Pine Tinto Medio Yellow Pine Dyed Medium Yellow Pine Teinté Moyenne	
		Okumè Tinto Ciliegio Okumè Dyed Cherry Okumè Teinté Cerise		Yellow Pine Tinto Verde Yellow Pine Dyed Green Yellow Pine Teinté Vert	
		Okumè Tinto Medio Okumè Dyed Medium Okumè Teinté Moyenne		Rovere Tinto Miele Oak Dyed Honey Chêne Teinté Miel	
		Okumè Tinto Verde Okumè Dyed Green Okumè Teinté Vert		Rovere Tinto Medio Oak Dyed Medium Chêne Teinté Moyenne	
		Tanganica Laccato RAL Tanganica lacquered RAL Tanganica laqué RAL		Frassino Tinto Medio Ash Dyed Medium Frêne Teinté Moyenne	
		Yellow Pine Tinto Chiaro Yellow Pine Dyed Clear Yellow Pine Teinté Clair		Frassino Laccato Poro aperto RAL Ash lacquered open pore RAL Frêne laqué à pores ouverts RAL	
Laccato colori standard Lacquered standard colors Couleurs standard laqués					
RAL (opzionale) RAL (optional) RAL (sur demande)					
	Finitura opaca (di serie) Matte finish (standard) Finition mate (standard)	Finitura lucida (opzionale) Glossy finish (optional) Finition brillante (sur demande)	Finitura goffrato fine (opzionale) Finish embossed (optional) Terminer en relief (sur demande)		

Modelli
Models
Modèles

K01 K01L K02 K02L K03 K03L K04 K04L
K05 K06 K07 K08 K09 K10 K11 K12 K13
K13L K14 K14L K15 K15L K16 K16L K17 K18
K19 K20 K21 K22 K23 K24 K25 K25L K26
K27 K28 K29 K30 K31 K32 K33 K34

Per lavorazioni personalizzate, contattare l'ufficio commerciale.
For working on the request to contact the sales office.
Pour travailler sur la demande de contacter le bureau des ventes.

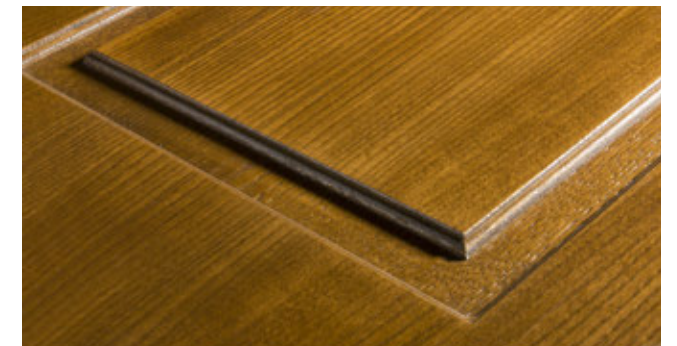
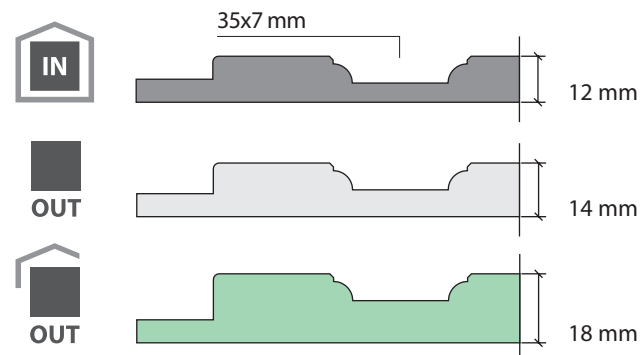

CRONO



Un effetto fugato discreto ed elegante che suddivide in modo geometrico la superficie. La modanatura a sbalzo con il suo design lineare è ideale sia per essenze legno che per laccature in tutti i colori RAL ed è pensata per resistere a medie e forti esposizioni agli agenti atmosferici.

A discreet and elegant effect dispelled that divides the surface geometrically. The Medici trim embossed with a sleek design and is ideal for both wood species for lacquering in all RAL colors and is designed to withstand medium and intense exposure to the elements.

Un effet discret et élégant dissipé qui divise la surface géométriquement. Les Médecins TRIM relief avec un design élégant et est idéal pour les essences de bois pour le laquage dans toutes les teintes RAL et est conçu pour résister à une exposition à moyen et intense pour les éléments.

Modelli
Models
Modèles

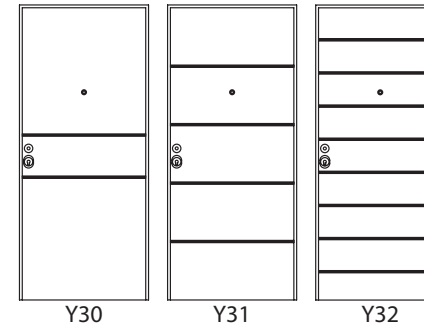

Per lavorazioni personalizzate, contattare l'ufficio commerciale.

For working on the request to contact the sales office.

Pour travailler sur la demande de contacter le bureau des ventes.

Fuori misura

Per mantenere lo stesso aspetto e la stessa proporzione del design anche nel caso di portoni con misure maggiori o con proporzioni diverse, il nostro ufficio tecnico sviluppa uno schema di suddivisione progettato ad hoc.

Out of size

To maintain the same look and the same proportion of the design even for doors with more or different proportions measures, our technical department develops a subdivision scheme designed ad hoc.

Des mesures supplémentaires

Pour maintenir le même aspect et la même proportion de la conception même pour les portes avec des proportions plus ou différentes mesures, notre département technique développe un schéma de subdivision conçu ad hoc.

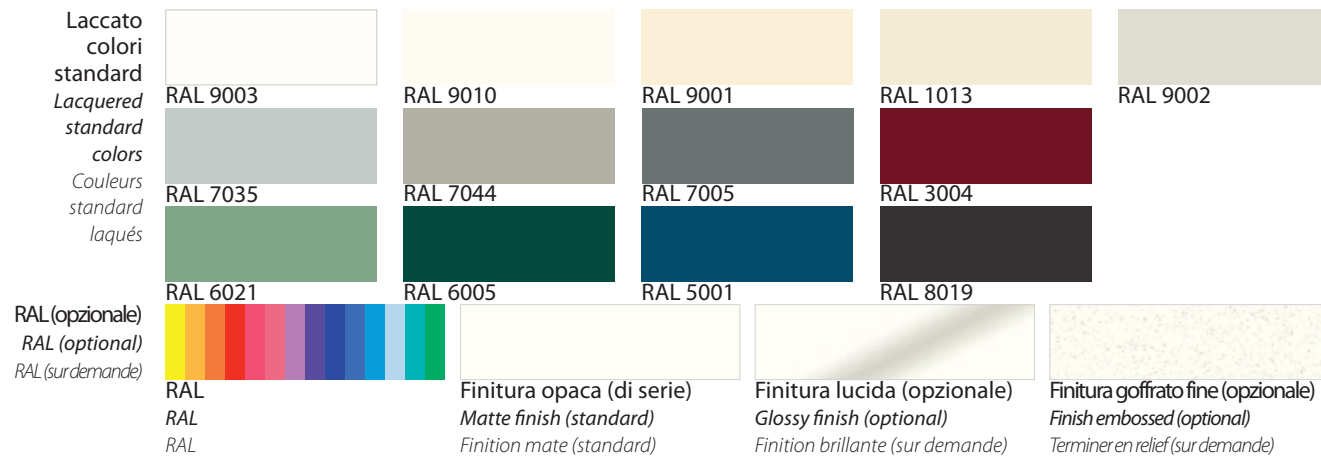

Sezione
Section
Section

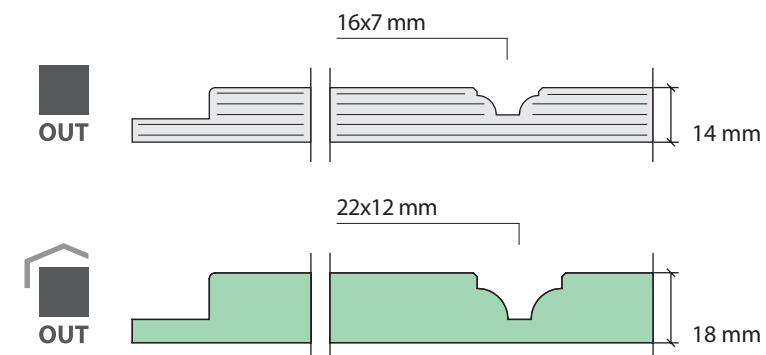



DIONISO



La geometria impeccabile delle incisioni quadre con angoli retti definisce un nuovo modo di disegnare la porta, essenziale e raffinato al tempo stesso sia nella versione laccata che nelle essenze legno. Adatto sia per esterni che per interni.

The perfect geometry of the square with rounded corners incisions defines a new way of drawing the door, essential and elegant at the same time both in the lacquered version and in the woods. Suitable for both outdoor and indoor.

La géométrie parfaite de la place avec des coins arrondis incisions définit une nouvelle façon de dessiner la porte, essentielle et élégante en même temps à la fois dans la version laquée et dans les bois. Convient à la fois intérieure et extérieure.

Modelli
Models
Modèles

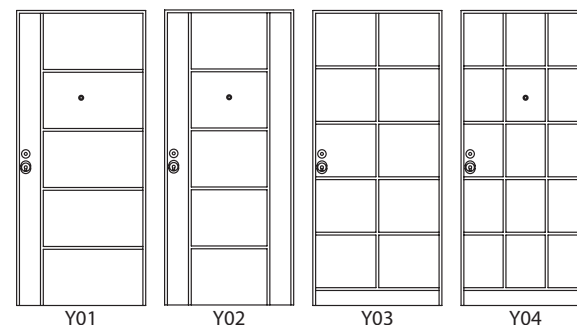

Per lavorazioni personalizzate, contattare l'ufficio commerciale.

For working on the request to contact the sales office.

Pour travailler sur la demande de contacter le bureau des ventes.

Fuori misura

Per mantenere lo stesso aspetto e la stessa proporzione del design anche nel caso di portoni con misure maggiori o con proporzioni diverse, il nostro ufficio tecnico sviluppa uno schema di suddivisione progettato ad hoc.

Out of size

To maintain the same look and the same proportion of the design even for doors with more or different proportions measures, our technical department develops a subdivision scheme designed ad hoc.

Des mesures supplémentaires

Pour maintenir le même aspect et la même proportion de la conception même pour les portes avec des proportions plus ou différentes mesures, notre département technique développe un schéma de subdivision conçu ad hoc.

Essenze e Finiture Essences and finishes Essences et finitions		Okumè Tinto Chiaro <i>Okumè Dyed Clear</i> <i>Okumè Teinté Clair</i>		Yellow Pine Tinto Medio <i>Yellow Pine Dyed Medium</i> <i>Yellow Pine Teinté Moyenne</i>
		Okumè Tinto Ciliegio <i>Okumè Dyed Cherry</i> <i>Okumè Teinté Cerise</i>		Yellow Pine Tinto Verde <i>Yellow Pine Dyed Green</i> <i>Yellow Pine Teinté Vert</i>
		Okumè Tinto Medio <i>Okumè Dyed Medium</i> <i>Okumè Teinté Moyenne</i>		Rovere Tinto Miele <i>Oak Dyed Honey</i> <i>Chêne Teinté Miel</i>
		Okumè Tinto Verde <i>Okumè Dyed Green</i> <i>Okumè Teinté Vert</i>		Rovere Tinto Medio <i>Oak Dyed Medium</i> <i>Chêne Teinté Moyenne</i>
		Tanganica Laccato RAL <i>Tanganica lacquered RAL</i> <i>Tanganica laqué RAL</i>		Frassino Tinto Medio <i>Ash Dyed Medium</i> <i>Frêne Teinté Moyenne</i>
		Yellow Pine Tinto Chiaro <i>Yellow Pine Dyed Clear</i> <i>Yellow Pine Teinté Clair</i>		Frassino Laccato Poro aperto RAL <i>Ash lacquered open pore RAL</i> <i>Frêne laqué à pores ouverts RAL</i>

Laccato colori standard Lacquered standard colors Couleurs standard laqués					
RAL (opzionale) RAL (optional) RAL (sur demande)					
	Finitura opaca (di serie) <i>Matte finish (standard)</i> <i>Finition mate (standard)</i>	Finitura lucida (opzionale) <i>Glossy finish (optional)</i> <i>Finition brillante (sur demande)</i>	Finitura goffrato fine (opzionale) <i>Finish embossed (optional)</i> <i>Terminer en relief (sur demande)</i>		

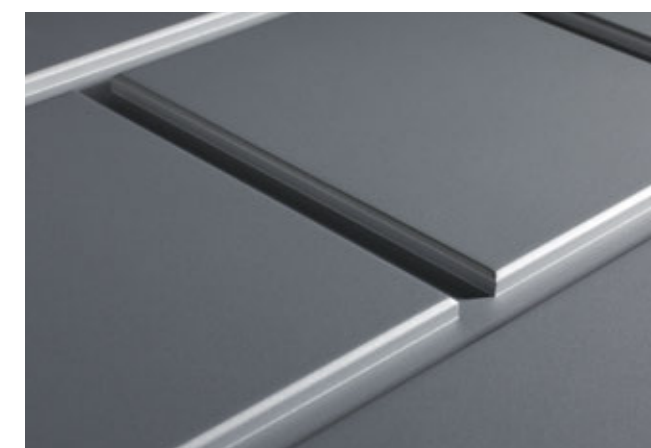
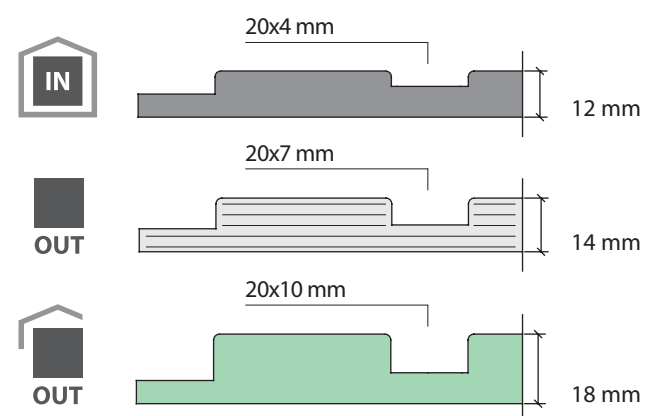

HERA



Le profonde modanature accentuano il gioco delle ombre per un classico universalmente riconosciuto, disponibile in un'ampia gamma di modelli e colorazioni e con numerose varianti anche con parti vetrate.

The deep moldings accentuate the play of shadows for a classic universally recognized, available in a wide range of designs and colors and with numerous variations with glass parts.

Les moulures profondes accentuent le jeu des ombres pour un classique universellement reconnu, disponible dans une large gamme de modèles et de couleurs et avec de nombreuses variantes avec des pièces de verre.

Modelli
Models
Modèles

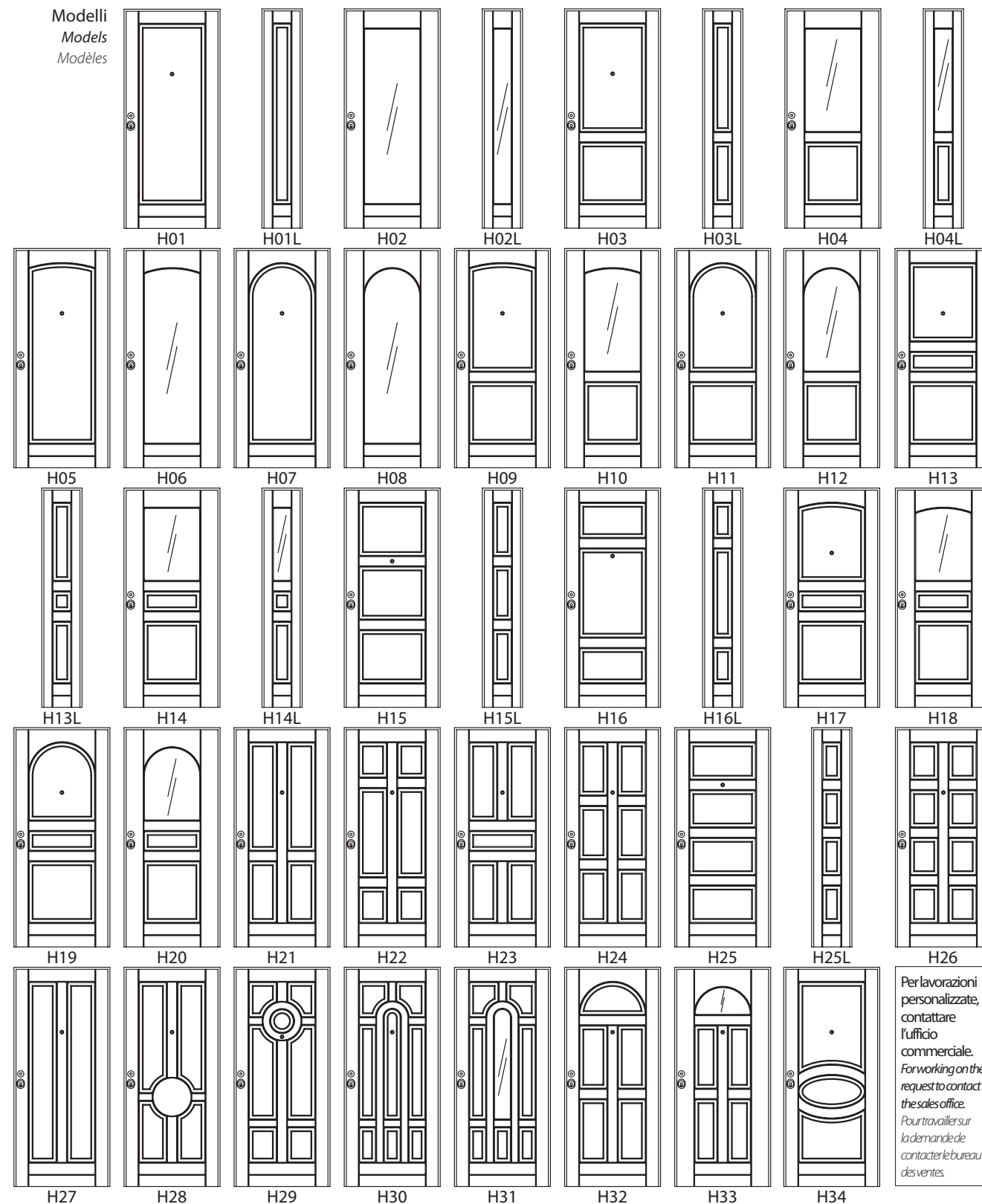

Per lavorazioni personalizzate, contattare l'ufficio commerciale.
For working on the request to contact the sales office.
Pour travailler sur la demande de contacter le bureau des ventes.

Laccato colori standard Lacquered standard colors Couleurs standard laqués					
	RAL 9003	RAL 9010	RAL 9001	RAL 1013	RAL 9002
	RAL 7035	RAL 7044	RAL 7005	RAL 3004	
	RAL 6021	RAL 6005	RAL 5001	RAL 8019	
RAL (opzionale) RAL (optional) RAL (sur demande)					
	RAL	RAL	RAL	RAL	RAL
		Finitura opaca (di serie) Matte finish (standard) Finition mate (standard)	Finitura lucida (opzionale) Glossy finish (optional) Finition brillante (sur demande)	Finitura goffrato fine (opzionale) Finish embossed (optional) Terminer en relief (sur demande)	

Sezione
Section
Section

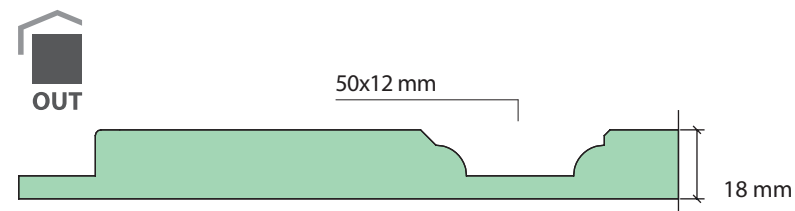



L'incisione squadrata a doppio livello conferisce a questa linea di pannelli di rivestimento un carattere contemporaneo e accattivante, che gioca con i contrasti tra luce e ombra e disegna uno schema dogato originale ed esclusivo.

The boxy etching dual level gives this line of wallboard a contemporary character and captivating, playing with the contrasts between light and shadow, and draws an original and exclusive staved scheme.

La gravure carrée double niveau donne cette ligne de plaques de plâtre d'un caractère contemporain et captivante, en jouant avec les contrastes entre ombre et lumière, et dessine un schéma à membrure original et exclusif.

Modelli
Models
Modèles

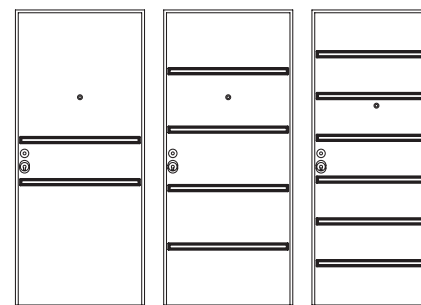

Y60

Y61

Y62

Per lavorazioni personalizzate, contattare l'ufficio commerciale.

For working on the request to contact the sales office.

Pour travailler sur la demande de contacter le bureau des ventes.

Fuori misura

Per mantenere lo stesso aspetto e la stessa proporzione del design anche nel caso di portoni con misure maggiori o con proporzioni diverse, il nostro ufficio tecnico sviluppa uno schema di suddivisione progettato ad hoc.

Out of size

To maintain the same look and the same proportion of the design even for doors with more or different proportions measures, our technical department develops a subdivision scheme designed ad hoc.

Des mesures supplémentaires

Pour maintenir le même aspect et la même proportion de la conception même pour les portes avec des proportions plus ou différentes mesures, notre département technique développe un schéma de subdivision conçu ad hoc.

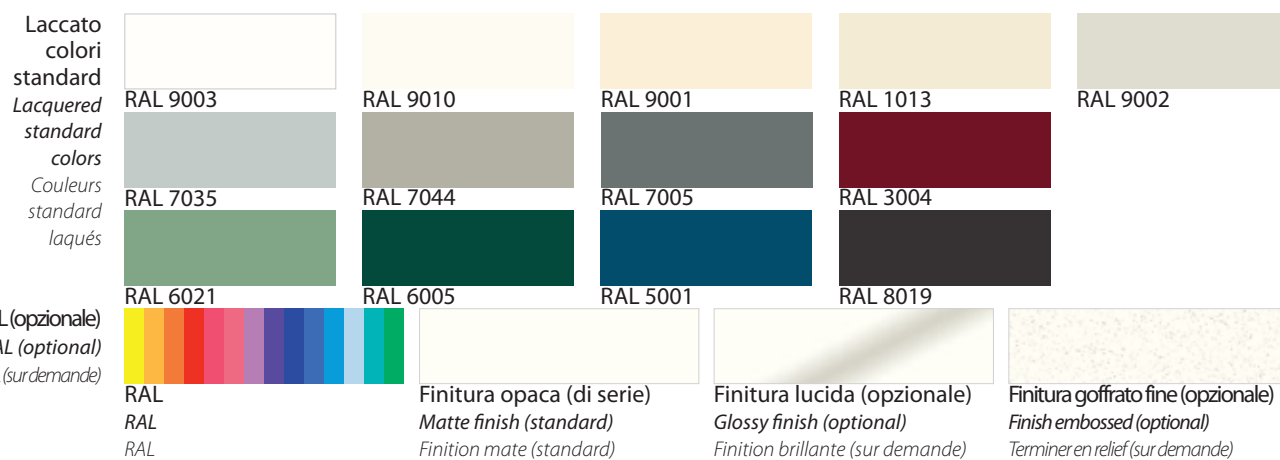

Sezione
Section
Section

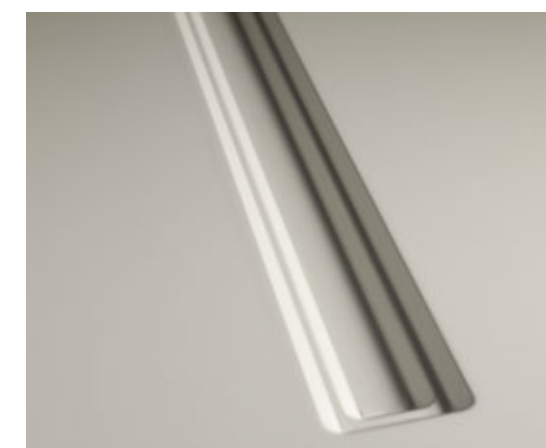
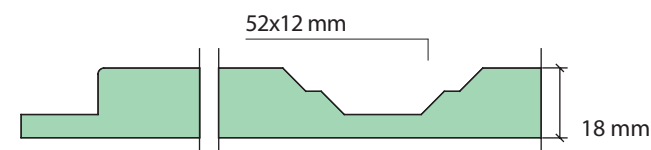

URANO

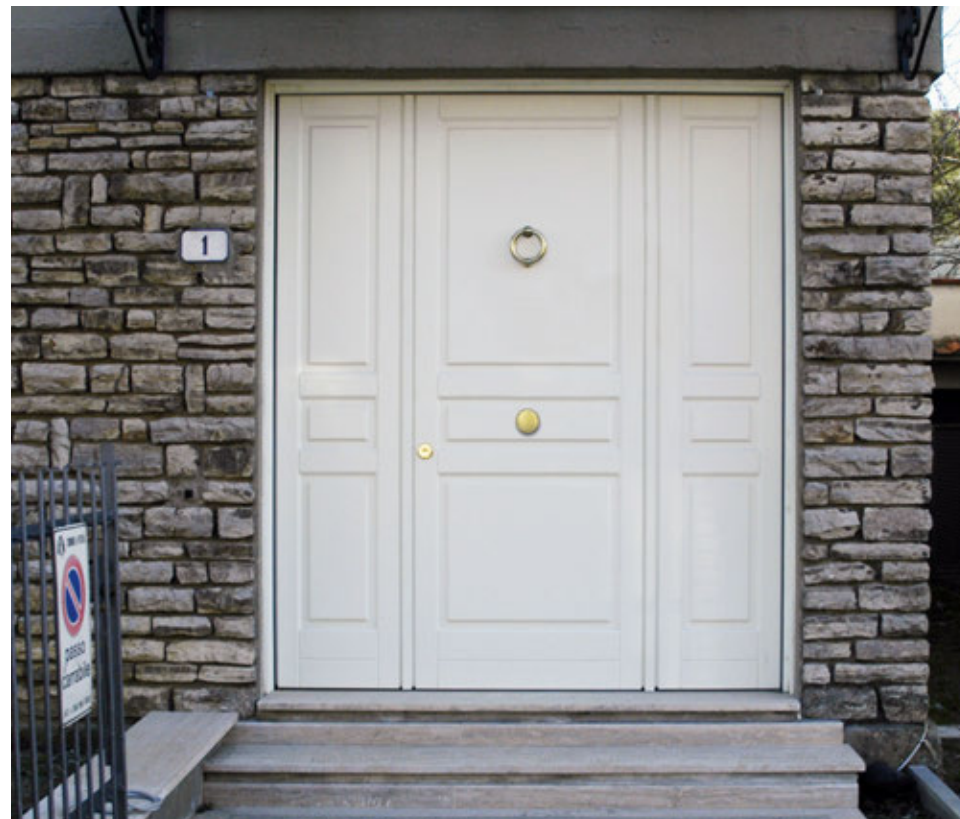

L'estetica contemporanea contamina questa linea di rivestimenti dal disegno classico e intramontabile composta da una cornice a filo che inquadra le bozze con profili a sbalzo. Autorevole nelle essenze legno, signorile nelle laccature RAL.

The contemporary aesthetics contaminates this line of coatings from the classic and timeless design consists of a wire frame around the drafts with profiles cantilever. Authoritative in the woods, in the stately RAL lacquers.

Les esthétique contemporaine contamine cette ligne de revêtements de la conception classique et intemporel est constitué d'un fil de fer autour des projets avec des profils en porte à faux. Autorité dans les bois, dans les laques RAL majestueuses.

Modelli
Models
Modèles

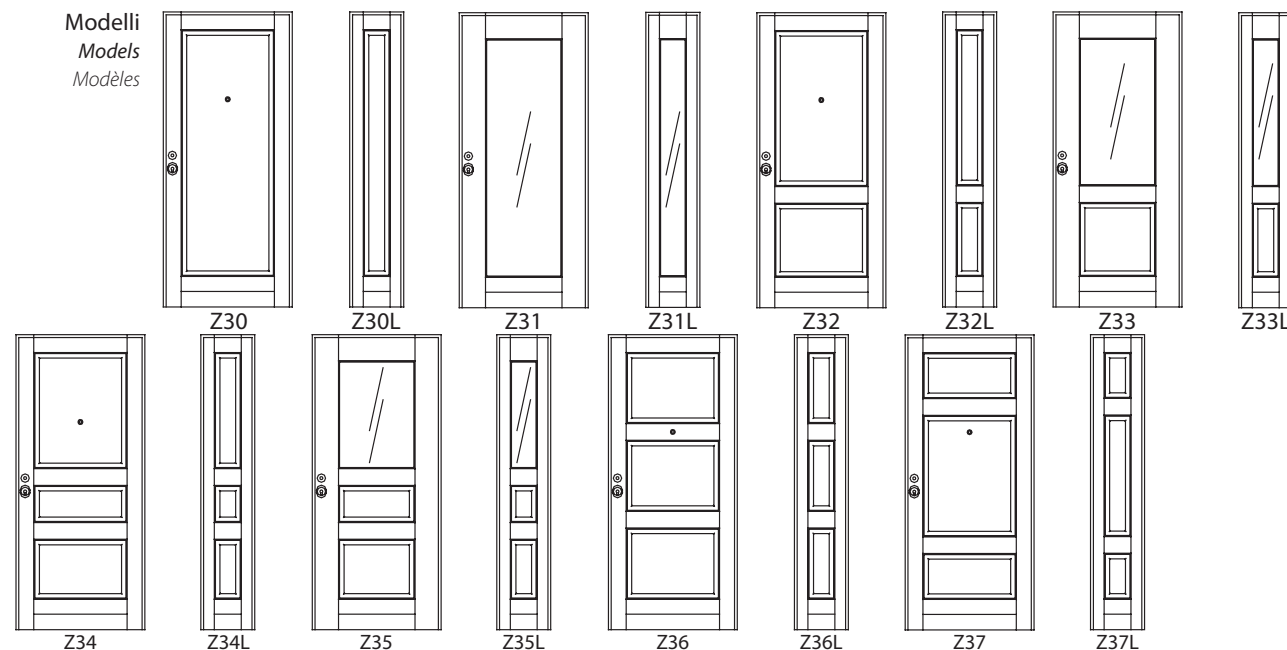

Per lavorazioni personalizzate, contattare l'ufficio commerciale.
For working on the request to contact the sales office.
Pour travailler sur la demande de contacter le bureau des ventes.

Essenze e Finiture Essences and finishes Essences et finitions		Tanganica Tinto Chiaro <i>Tanganica Dyed Clear</i> <i>Tanganica Teinté Clair</i>		Yellow Pine Tinto Medio <i>Yellow Pine Dyed Medium</i> <i>Yellow Pine Teinté Moyenne</i>
		Tanganica Tinto Ciliegio <i>Tanganica Dyed Cherry</i> <i>Tanganica Teinté Cerise</i>		Yellow Pine Tinto Verde <i>Yellow Pine Dyed Green</i> <i>Yellow Pine Teinté Vert</i>
		Tanganica Tinto Medio <i>Tanganica Dyed Medium</i> <i>Tanganica Teinté Moyenne</i>		Rovere Tinto Miele <i>Oak Dyed Honey</i> <i>Chêne Teinté Miel</i>
		Tanganica Tinto Verde <i>Tanganica Dyed Green</i> <i>Tanganica Teinté Vert</i>		Rovere Tinto Medio <i>Oak Dyed Medium</i> <i>Chêne Teinté Moyenne</i>
		Tanganica Laccato RAL <i>Tanganica lacquered RAL</i> <i>Tanganica laqué RAL</i>		Frassino Tinto Medio <i>Ash Dyed Medium</i> <i>Frêne Teinté Moyenne</i>
		Yellow Pine Tinto Chiaro <i>Yellow Pine Dyed Clear</i> <i>Yellow Pine Teinté Clair</i>		Frassino Laccato Poro aperto RAL <i>Ash lacquered open pore RAL</i> <i>Frêne laqué à pores ouverts RAL</i>

Laccato colori standard Lacquered standard colors Couleurs standard laqués					
RAL (opzionale) RAL (optional) RAL (sur demande)					
		Finitura opaca (di serie) <i>Matte finish (standard)</i> <i>Finition mate (standard)</i>	Finitura lucida (opzionale) <i>Glossy finish (optional)</i> <i>Finition brillante (sur demande)</i>	Finitura goffrato fine (opzionale) <i>Finish embossed (optional)</i> <i>Terminer en relief (sur demande)</i>	

Fuori misura
Per mantenere lo stesso aspetto e la stessa proporzione del design anche nel caso di portoni con misure maggiori o con proporzioni diverse, il nostro ufficio tecnico sviluppa uno schema di suddivisione progettato ad hoc.

Out of size
To maintain the same look and the same proportion of the design even for doors with more or different proportions measures, our technical department develops a subdivision scheme designed ad hoc.

Des mesures supplémentaires
Pour maintenir le même aspect et la même proportion de la conception même pour les portes avec des proportions plus ou différentes mesures, notre département technique développe un schéma de subdivision et conçu ad hoc.

Sezione
Section
Section

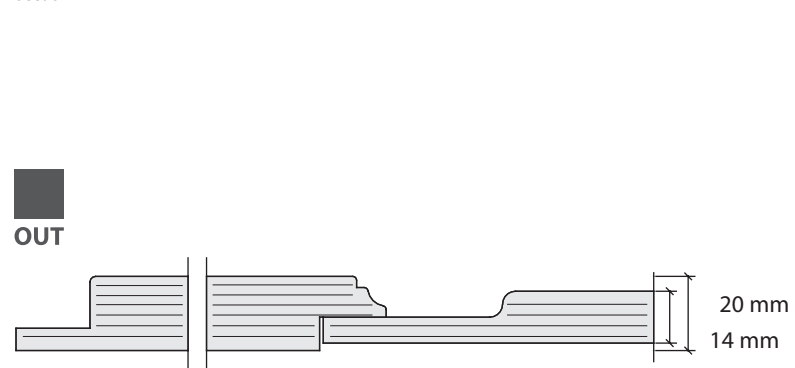



APOLLO



APOLLO A



APOLLO B

Elevate prestazioni strutturali e di resistenza agli agenti atmosferici garantite dall'accoppiamento di legno massello e multistrato, declinato in una gamma di modelli dal disegno classico e intramontabile.

High structural performance and weather resistance guaranteed by the coupling of solid wood and plywood, available in a range of models from the classic and timeless design.

Performance structurelle élevée et une résistance aux intempéries garantie par le couplage de bois massif et contreplaqué, disponibles dans une gamme de modèles de la conception classique et intemporel.

Modelli
Models
Modèles

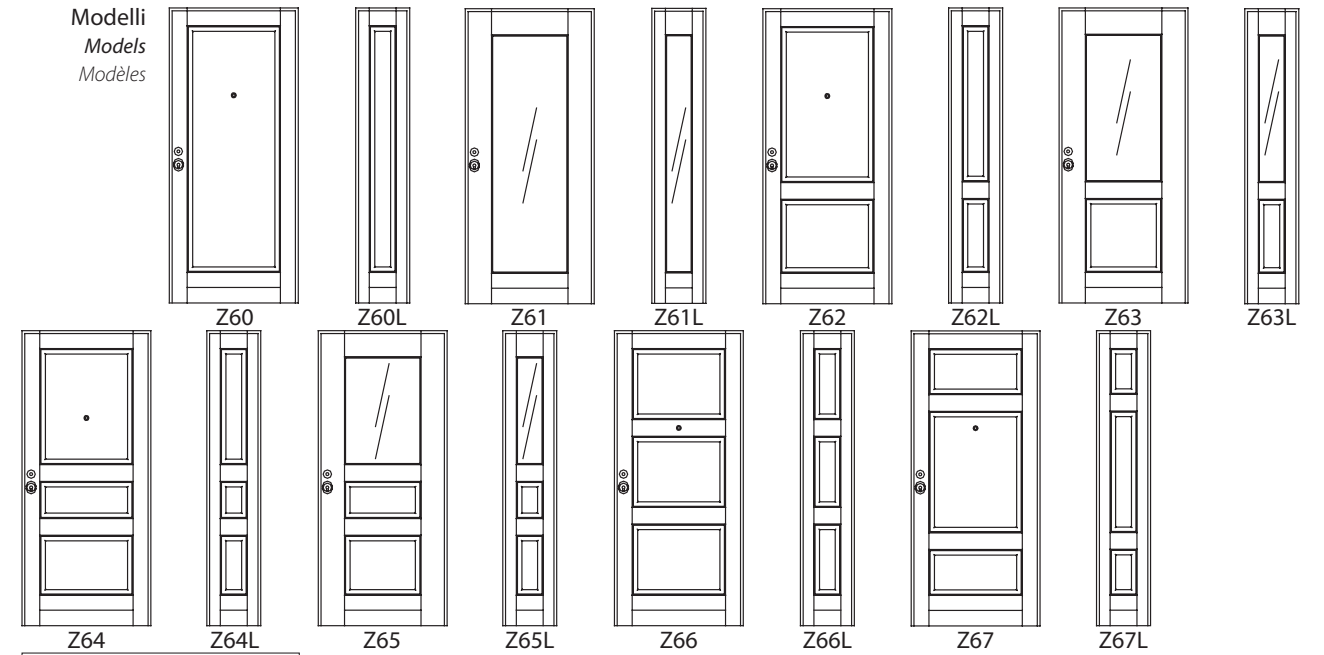

Per lavorazioni personalizzate, contattare l'ufficio commerciale.

For working on the request to contact the sales office.

Pour travailler sur la demande de contacter le bureau des ventes.

Essenze e Finiture Essences and finishes Essences et finitions		Tanganica Tinto Chiaro <i>Tanganica Dyed Clear</i> <i>Tanganica Teinté Clair</i>		Yellow Pine Tinto Medio <i>Yellow Pine Dyed Medium</i> <i>Yellow Pine Teinté Moyenne</i>
		Tanganica Tinto Ciliegio <i>Tanganica Dyed Cherry</i> <i>Tanganica Teinté Cerise</i>		Yellow Pine Tinto Verde <i>Yellow Pine Dyed Green</i> <i>Yellow Pine Teinté Vert</i>
		Tanganica Tinto Medio <i>Tanganica Dyed Medium</i> <i>Tanganica Teinté Moyenne</i>		Rovere Tinto Miele <i>Oak Dyed Honey</i> <i>Chêne Teinté Miel</i>
		Tanganica Tinto Verde <i>Tanganica Dyed Green</i> <i>Tanganica Teinté Vert</i>		Rovere Tinto Medio <i>Oak Dyed Medium</i> <i>Chêne Teinté Moyenne</i>
		Tanganica Laccato RAL <i>Tanganica lacquered RAL</i> <i>Tanganica laqué RAL</i>		Frassino Tinto Medio <i>Ash Dyed Medium</i> <i>Frêne Teinté Moyenne</i>
		Yellow Pine Tinto Chiaro <i>Yellow Pine Dyed Clear</i> <i>Yellow Pine Teinté Clair</i>		Frassino Laccato Poro aperto RAL <i>Ash lacquered open pore RAL</i> <i>Frêne laqué à pores ouverts RAL</i>

Laccato colori standard Lacquered standard colors Couleurs standard laqués					
RAL (opzionale) RAL (optional) RAL (sur demande)					
		Finitura opaca (di serie) <i>Matte finish (standard)</i> <i>Finition mate (standard)</i>	Finitura lucida (opzionale) <i>Glossy finish (optional)</i> <i>Finition brillante (sur demande)</i>	Finitura goffrato fine (opzionale) <i>Finish embossed (optional)</i> <i>Terminer en relief (sur demande)</i>	

Fuori misura
Per mantenere lo stesso aspetto e la stessa proporzione del design anche nel caso di portoni con misure maggiori o con proporzioni diverse, il nostro ufficio tecnico sviluppa uno schema di suddivisione progettato ad hoc.

Out of size
To maintain the same look and the same proportion of the design even for doors with more or different proportions measures, our technical department develops a subdivision scheme designed ad hoc.

Des mesures supplémentaires
Pour maintenir le même aspect et la même proportion de la conception même pour les portes avec des proportions plus ou différentes mesures, notre département technique développe un schéma de subdivision et conçu ad hoc.

Sezione
Section
Section

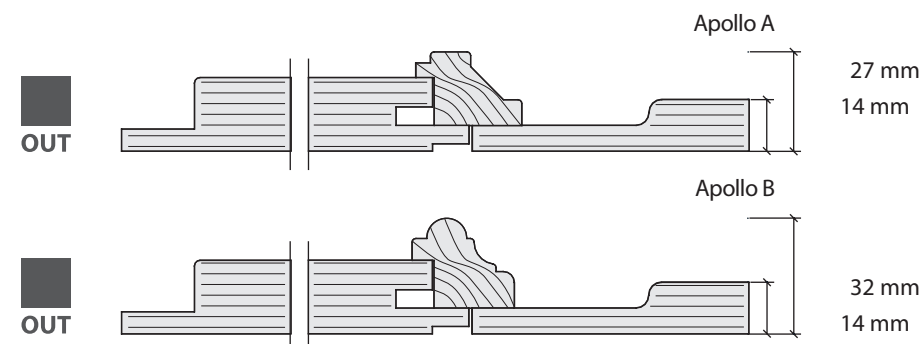

GRANDUCATO MASSELLO



L'autenticità del legno massello si sposa con le linee della tradizione toscana di GRANDUCATO MASSELLO. Le essenze e le finiture disponibili sono in grado di assecondare i progetti più esclusivi con uno stile intramontabile.

The authenticity of solid wood blends with the lines of the Tuscan tradition of solid Duchy. The essences and finishes available are able to satisfy the most exclusive projects with a timeless style.

L'authenticité de bois massif se confond avec les lignes de la tradition toscane du Duché solide. Les essences et finitions disponibles sont en mesure de répondre aux projets les plus exclusifs avec un style intemporel.

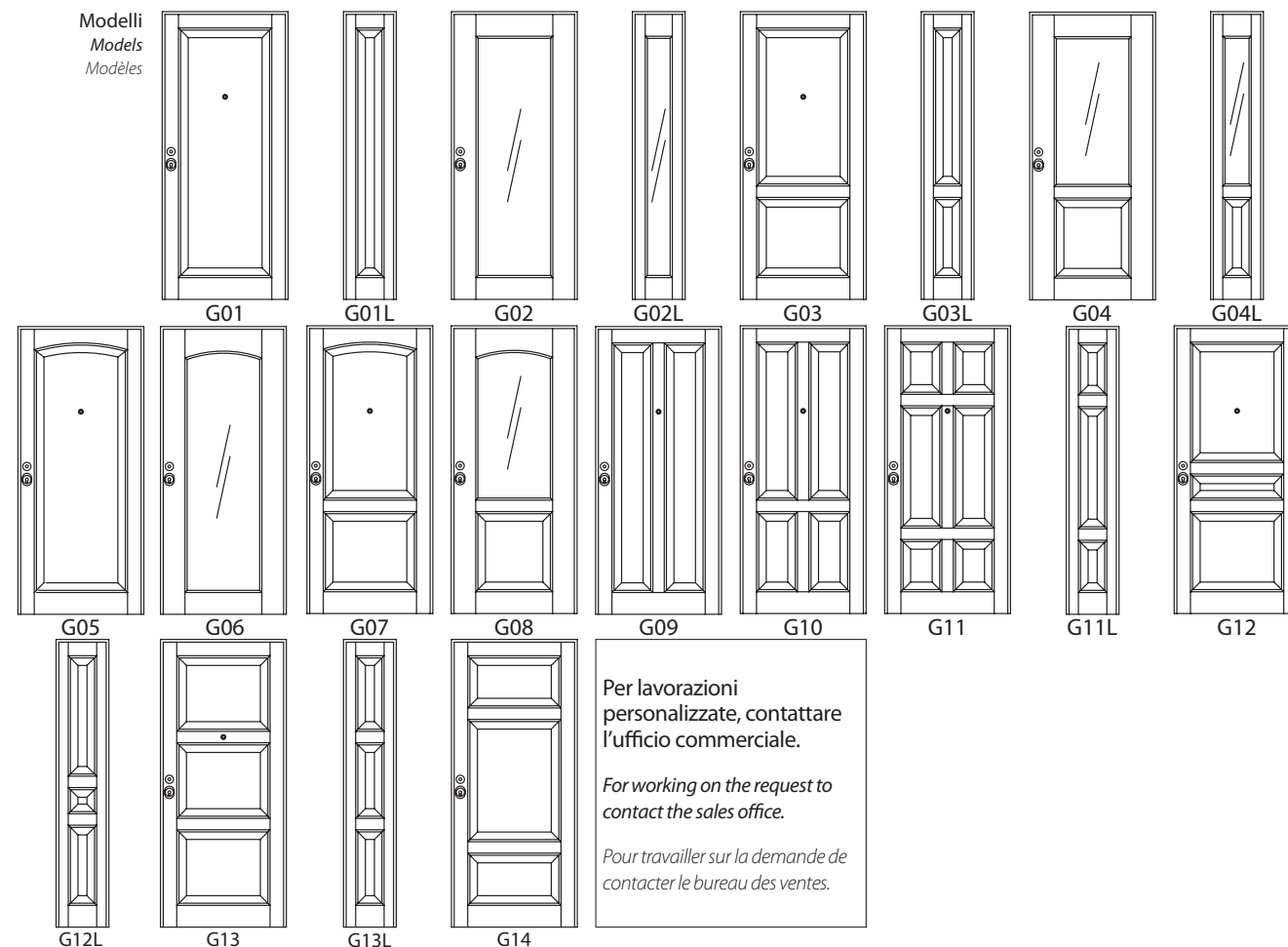

Per lavorazioni personalizzate, contattare l'ufficio commerciale.
For working on the request to contact the sales office.
Pour travailler sur la demande de contacter le bureau des ventes.

Fuori misura
Per mantenere lo stesso aspetto e la stessa proporzione del design anche nel caso di portoni con misure maggiori o con proporzioni diverse, il nostro ufficio tecnico sviluppa uno schema di suddivisione progettato ad hoc.

Out of size
To maintain the same look and the same proportion of the design even for doors with more or different proportions measures, our technical department develops a subdivision scheme designed ad hoc.

Des mesures supplémentaires
Pour maintenir le même aspect et la même proportion de la conception même pour les portes avec des proportions plus ou différentes mesures, notre département technique développe un schéma de subdivision conçu ad hoc.

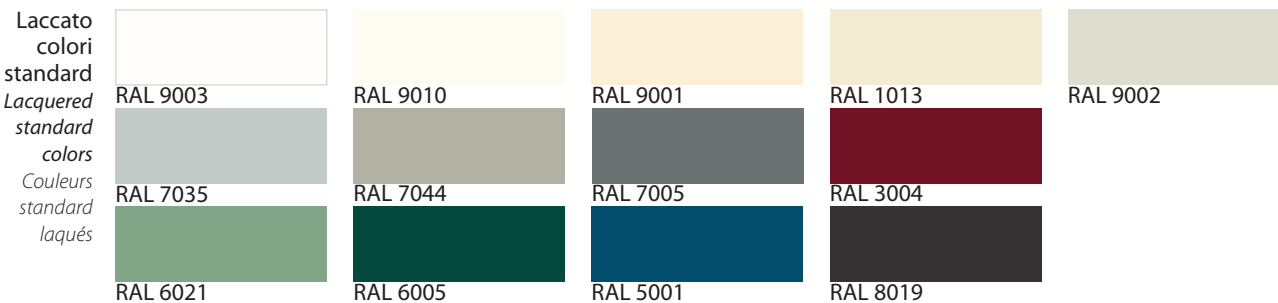

Sezione
Section
Section

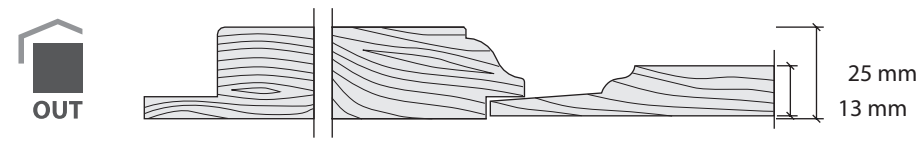



Il calore del legno massello, la ricchezza della cornice in rilievo, le bozze con profili a sbalzo: ogni dettaglio di questa linea è pensato per trasmettere il carattere genuino di una porta senza tempo.

The warmth of solid wood, the richness of the frame in relief, drafts with embossed profiles: every detail of this line is meant to convey the genuine character of a door timeless.

La chaleur du bois massif, la richesse de la trame en relief, rédigé avec des profils en relief: chaque détail de cette ligne est destinée à transmettre le caractère véritable d'une porte hors du temps.

Modelli
Models
Modèles

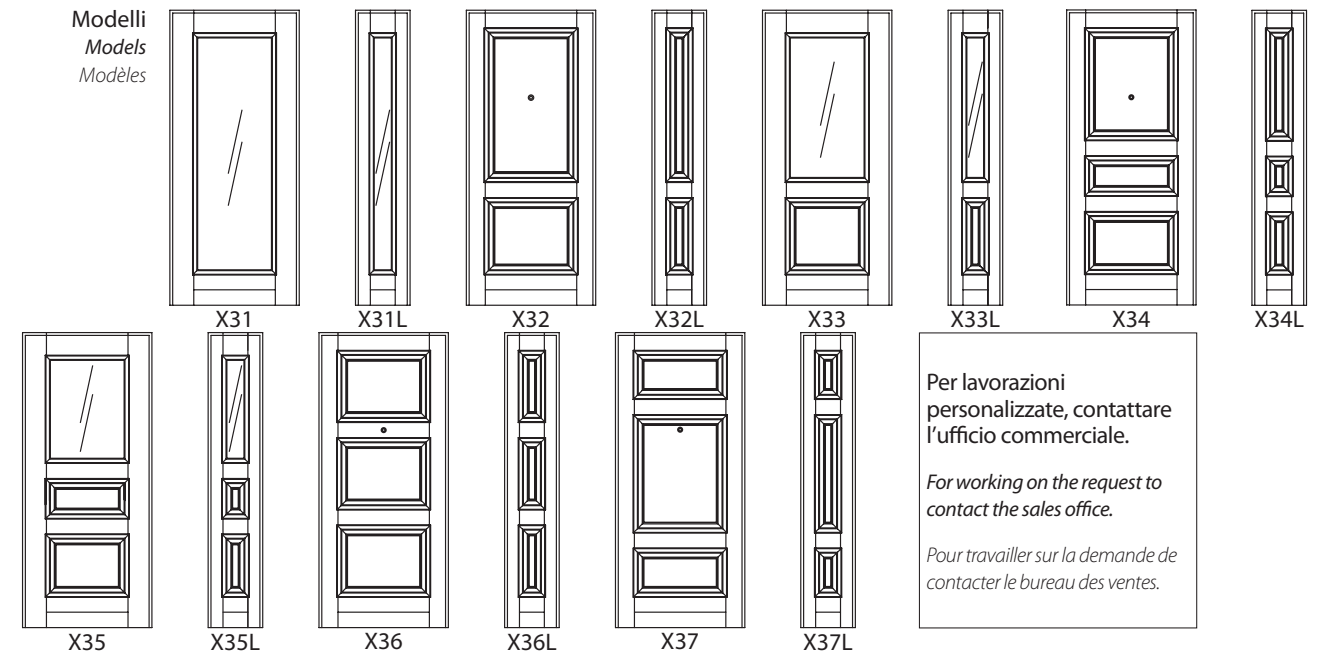

Per lavorazioni personalizzate, contattare l'ufficio commerciale.

For working on the request to contact the sales office.

Pour travailler sur la demande de contacter le bureau des ventes.

Fuori misura

Per mantenere lo stesso aspetto e la stessa proporzione del design anche nel caso di portoni con misure maggiori o con proporzioni diverse, il nostro ufficio tecnico sviluppa uno schema di suddivisione progettato ad hoc.

Out of size

To maintain the same look and the same proportion of the design even for doors with more or different proportions measures, our technical department develops a subdivision scheme designed ad hoc.

Des mesures supplémentaires

Pour maintenir le même aspect et la même proportion de la conception même pour les portes avec des proportions plus ou différentes mesures, notre département technique développe un schéma de subdivision conçu ad hoc.

Essenze e Finiture Essences and finishes Essences et finitions		Toulipier Tinto Chiaro <i>Toulipier Dyed Clear</i> <i>Toulipier Teinté Clair</i>		Yellow Pine Tinto Verde <i>Yellow Pine Dyed Green</i> <i>Yellow Pine Teinté Vert</i>
		Toulipier Tinto Ciliegio <i>Toulipier Dyed Cherry</i> <i>Toulipier Teinté Cerise</i>		Castagno Tinto Medio <i>Chestnut Dyed Medium</i> <i>Châtaigne Teinté Moyenne</i>
		Toulipier Tinto Medio <i>Toulipier Dyed Medium</i> <i>Toulipier Teinté Moyenne</i>		Castagno Laccato a Poro aperto RAL <i>Open Pore Lacquered RAL Chestnut</i> <i>Châtaigne Laqué Pore ouvert RAL</i>
		Toulipier Laccato RAL <i>Toulipier lacquered RAL</i> <i>Toulipier laqué RAL</i>		Rovere Tinto Miele <i>Oak Dyed Honey</i> <i>Chêne Teinté Miel</i>
		Yellow Pine Tinto Chiaro <i>Yellow Pine Dyed Clear</i> <i>Yellow Pine Teinté Clair</i>		Rovere Tinto Medio <i>Oak Dyed Medium</i> <i>Chêne Teinté Moyenne</i>
		Yellow Pine Tinto Medio <i>Yellow Pine Dyed Medium</i> <i>Yellow Pine Teinté Moyenne</i>		Noce Nazionale Tinto Medio <i>Italian Walnut Dyed Medium</i> <i>Noyer Italien Teinté Moyenne</i>

Laccato colori standard Lacquered standard colors Couleurs standard laqués					
RAL (opzionale) RAL (optional) RAL (sur demande)					
	Finitura opaca (di serie) <i>Matte finish (standard)</i> <i>Finition mate (standard)</i>	Finitura lucida (opzionale) <i>Glossy finish (optional)</i> <i>Finition brillante (sur demande)</i>	Finitura goffrato fine (opzionale) <i>Finish embossed (optional)</i> <i>Terminer en relief (sur demande)</i>		

Sezione
Section
Section

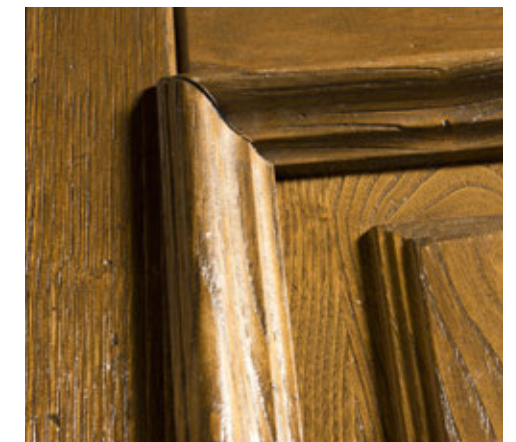
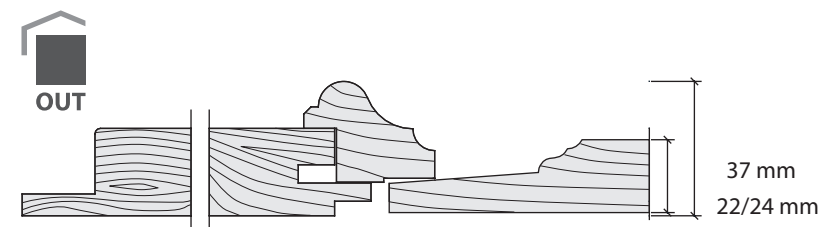

GIOVE





La linea Giove è la regina dei portoni in legno massello grazie alla doppia cornice che inquadra le bozze con profili a sbalzo. Per un design imponente, solido e maestoso come la divinità romana da cui prende il nome.

The Jupiter line is the queen of solid wood doors thanks to the double frame around the drafts with profiles cantilever. For an impressive design, solid and majestic like the Roman god that gives it its name.

La ligne Jupiter est la reine des portes en bois massif grâce au double cadre autour des projets avec des profils en porte à faux. Pour un design impressionnant, solide et majestueux comme le dieu romain qui lui donne son nom.

Modelli
Models
Modèles

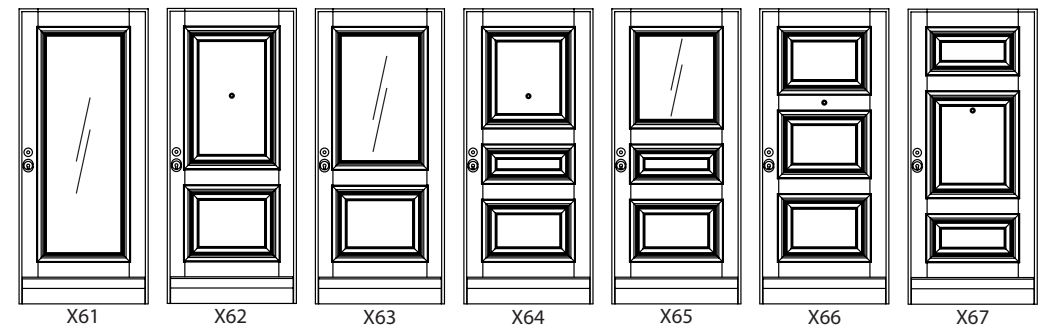

Per lavorazioni personalizzate, contattare l'ufficio commerciale.

For working on the request to contact the sales office.

Pour travailler sur la demande de contacter le bureau des ventes.

Fuori misura

Per mantenere lo stesso aspetto e la stessa proporzione del design anche nel caso di portoni con misure maggiori o con proporzioni diverse, il nostro ufficio tecnico sviluppa uno schema di suddivisione progettato ad hoc.

Out of size

To maintain the same look and the same proportion of the design even for doors with more or different proportions measures, our technical department develops a subdivision scheme designed ad hoc.

Des mesures supplémentaires

Pour maintenir le même aspect et la même proportion de la conception même pour les portes avec des proportions plus ou différentes mesures, notre département technique développe un schéma de subdivision et conçu ad hoc.

Essenze e Finiture Essences and finishes Essences et finitions		Touliplier Tinto Chiaro <i>Touliplier Dyed Clear</i> <i>Touliplier Teinté Clair</i>		Yellow Pine Tinto Verde <i>Yellow Pine Dyed Green</i> <i>Yellow Pine Teinté Vert</i>
		Touliplier Tinto Ciliegio <i>Touliplier Dyed Cherry</i> <i>Touliplier Teinté Cerise</i>		Castagno Tinto Medio <i>Chestnut Dyed Medium</i> <i>Châtaigne Teinté Moyenne</i>
		Touliplier Tinto Medio <i>Touliplier Dyed Medium</i> <i>Touliplier Teinté Moyenne</i>		Castagno Laccato a Poro aperto RAL <i>Open Pore Lacquered RAL Chestnut</i> <i>Châtaigne Laqué Pore ouvert RAL</i>
		Touliplier Laccato RAL <i>Touliplier lacquered RAL</i> <i>Touliplier laqué RAL</i>		Rovere Tinto Miele <i>Oak Dyed Honey</i> <i>Chêne Teinté Miel</i>
		Yellow Pine Tinto Chiaro <i>Yellow Pine Dyed Clear</i> <i>Yellow Pine Teinté Clair</i>		Rovere Tinto Medio <i>Oak Dyed Medium</i> <i>Chêne Teinté Moyenne</i>
		Yellow Pine Tinto Medio <i>Yellow Pine Dyed Medium</i> <i>Yellow Pine Teinté Moyenne</i>		Noce Nazionale Tinto Medio <i>Italian Walnut Dyed Medium</i> <i>Noyer Italien Teinté Moyenne</i>

Laccato colori standard Lacquered standard colors Couleurs standard laqués					
	RAL 9003	RAL 9010	RAL 9001	RAL 1013	RAL 9002
	RAL 7035	RAL 7044	RAL 7005	RAL 3004	
RAL (opzionale) RAL (optional) RAL (sur demande)					
	RAL 6021	RAL 6005	RAL 5001	RAL 8019	
	Finitura opaca (di serie) <i>Matte finish (standard)</i> <i>Finition mate (standard)</i>	Finitura lucida (opzionale) <i>Glossy finish (optional)</i> <i>Finition brillante (sur demande)</i>	Finitura goffrato fine (opzionale) <i>Finish embossed (optional)</i> <i>Terminer en relief (sur demande)</i>		

Sezione
Section
Section

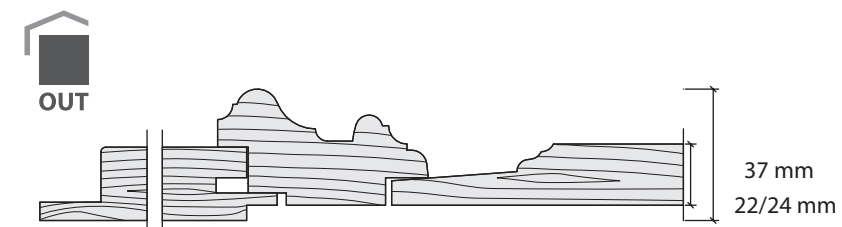

POSEIDONE



POSEIDONE



Realizzati con HDF idrorepellente e rifiniti con pellicole colorate in PVC ad alta resistenza, i pannelli della linea POSEIDONE rappresentano il giusto connubio tra la tradizione dei modelli e l'innovazione dei materiali.

HDF made with waterproof and finished with colored films in high resistance PVC, the panels of the Aphrodite line represents the perfect union between the tradition of the models and materials innovation.

HDF fait avec imperméable à l'eau et a terminé avec des films colorés à haute résistance PVC, les panneaux de la ligne Aphrodite représente l'union parfaite entre la tradition des modèles et des matériaux innovation.

Per la gamma di colori e finiture consultare pag. 224
For the range of colors and finishes see p. 224
Pour la gamme de couleurs et finitions voir p. 224

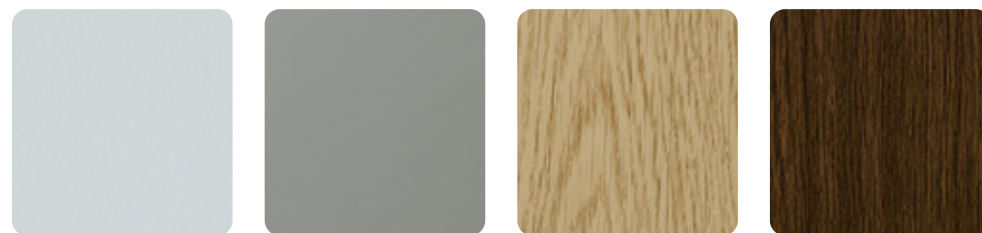

Modelli
Models
Modèles

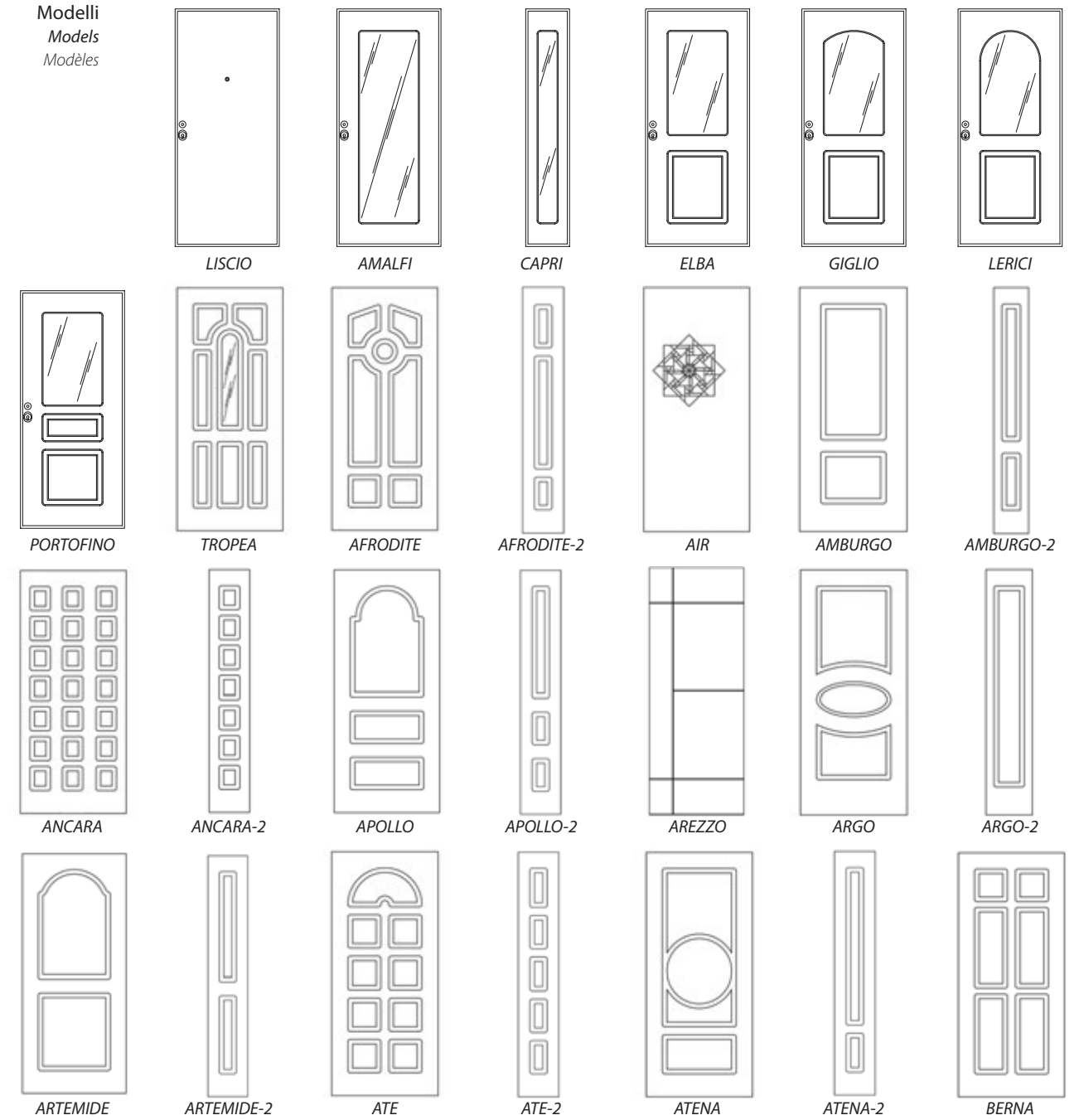

Sezione
Section
Section

OUT

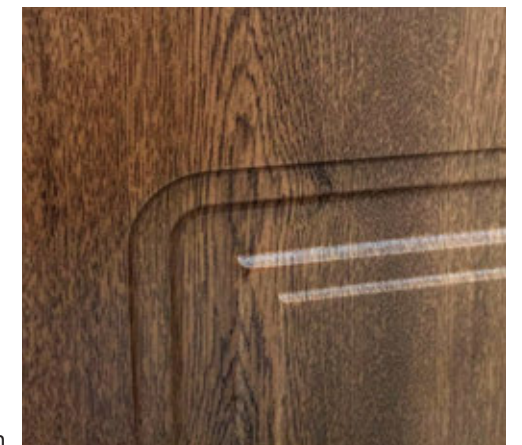
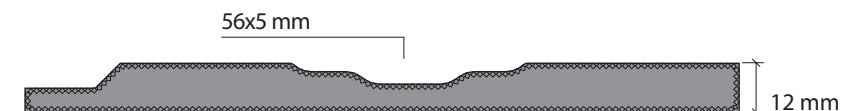

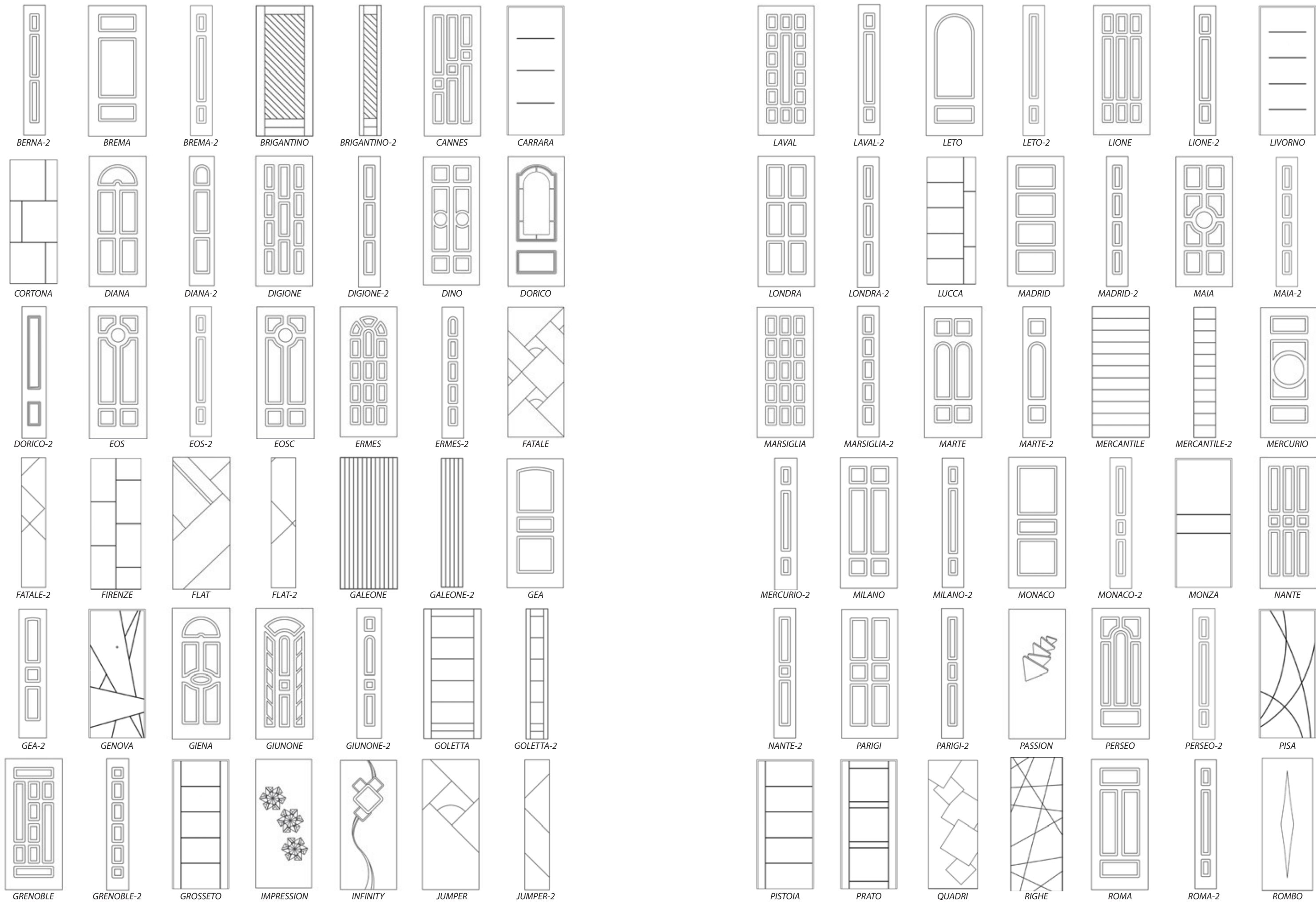

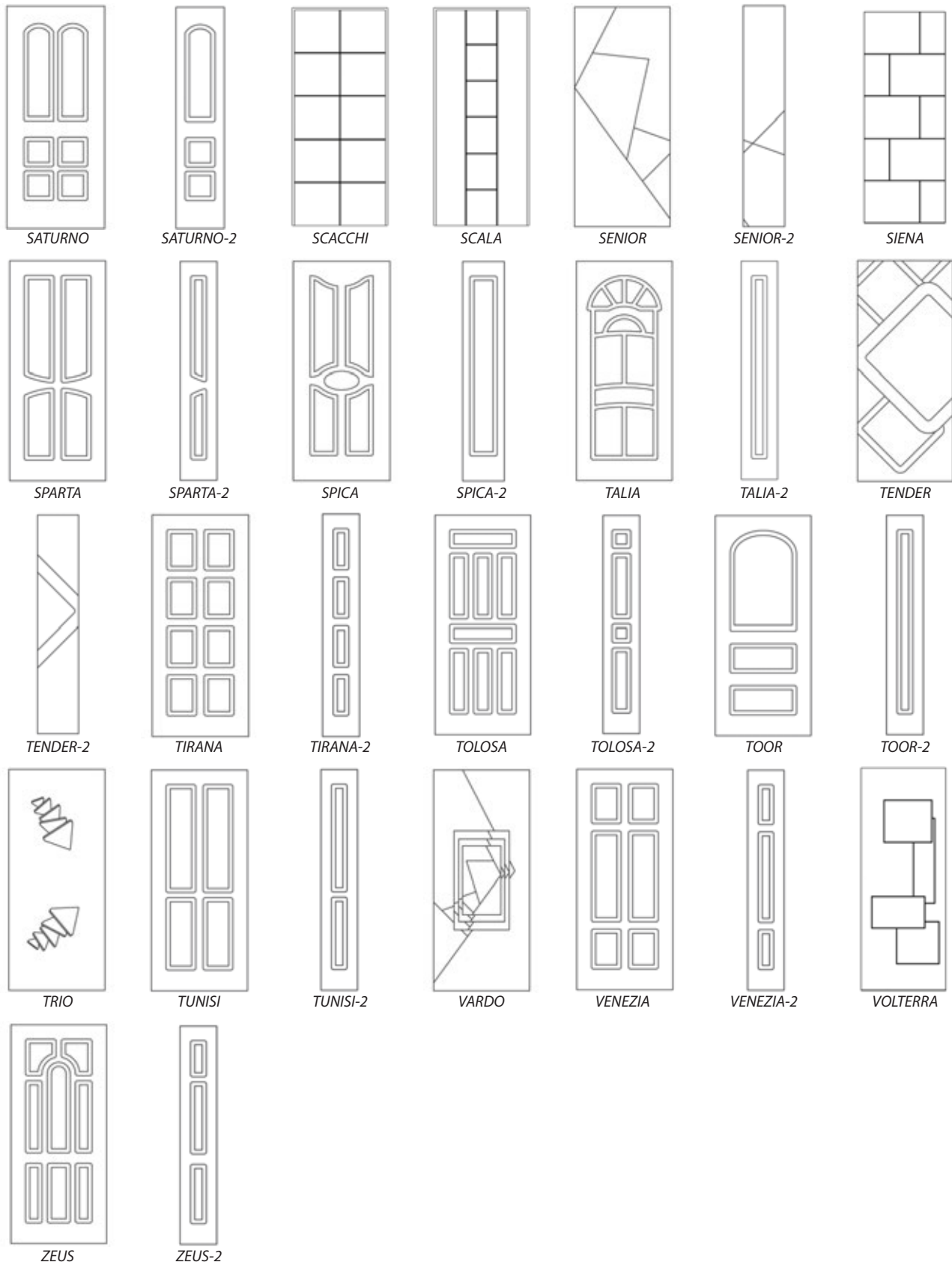

STONE



STONE



La pietra, utilizzata in edilizia sin dai tempi più antichi, impreziosisce oggi i pannelli della serie Stone col suo aspetto naturale ed elegantemente rassicurante. Vere lastre di Ardesia e Quarzite incastonate in pannelli pantografati, esaltano l'omogeneità dell'MDF laccato, garantendo altresì robustezza e resistenza agli agenti atmosferici. L'estetica forte e vibrante della pietra sposa idealmente ambienti sofisticati ed eleganti, mentre l'unicità delle venature dona ai singoli pannelli un design esclusivo e irripetibile.

Stone, used in construction since ancient times, today embellishes the panels of the Stone series with its natural and elegantly reassuring appearance. Real slabs of Slate and Quartzite set in pantographed panels, enhance the homogeneity of the lacquered MDF, while also ensuring strength and resistance to atmospheric agents. The strong and vibrant aesthetic of the stone ideally marries sophisticated and elegant environments, while the uniqueness of the veins gives the individual panels an exclusive and unrepeatable design.

La pierre, utilisée dans la construction depuis l'Antiquité, embellit aujourd'hui les panneaux de la série Stone avec son aspect naturel et élégamment rassurant. De véritables dalles d'Ardoise et de Quartzite serties dans des panneaux pantographiés, renforcent l'homogénéité du MDF laqué, tout en garantissant solidité et résistance aux agents atmosphériques. L'esthétique forte et vibrante de la pierre épouse idéalement des environnements sophistiqués et élégants, tandis que l'unicité des veines donne aux panneaux individuels un design exclusif et unique.

Modelli
Models
Modèles



METEORA



METEORA-2



MONOLITE



MONOLITE-2



PETRA



PETRA-2

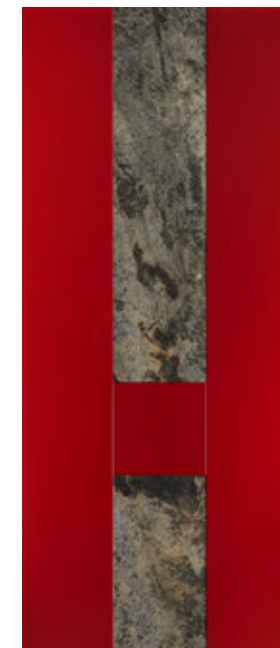

SERENA

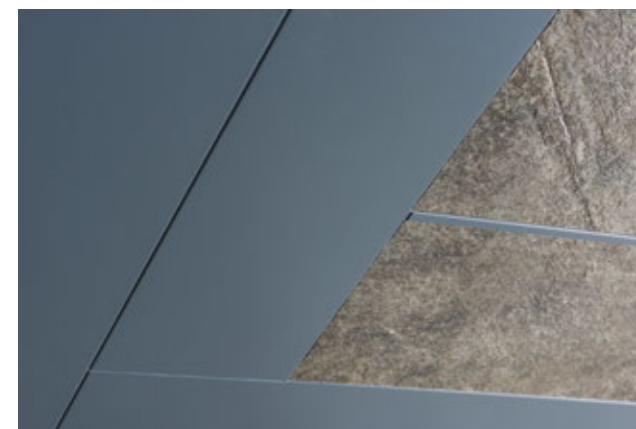

STAINLESS



STAINLESS

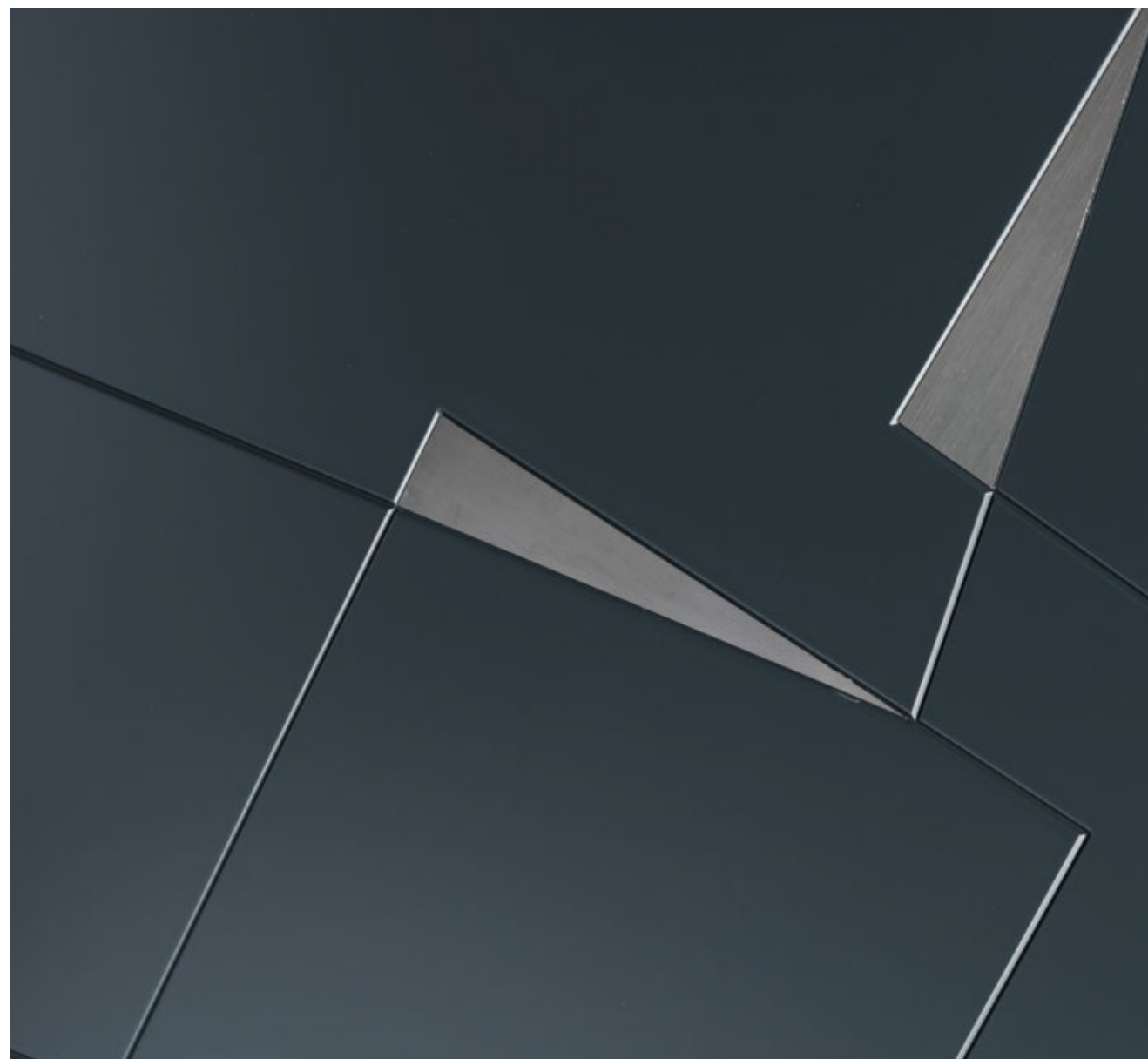

I pannelli pantografati della linea Stainless si caratterizzano per un felice connubio di raffinatezza nelle linee ed elevata resistenza ad usura e agenti atmosferici. Ogni pannello è impreziosito da inserti in acciaio inox, a sottolineare la ricerca di linee pulite con stilosi tagli di luce. Il design della linea Stainless valorizza l'estetica di spazi moderni e curati, con finiture dall'ampia gamma dei colori RAL.

The pantographed panels of the Stainless line are characterized by a happy combination of refinement in the lines and high resistance to wear and atmospheric agents. Each panel is embellished with stainless steel inserts, to underline the search for clean lines with stylish cuts of light. The design of the Stainless line enhances the aesthetics of modern and well-finished spaces, with finishes from the wide range of RAL colors.

Les panneaux pantographiés de la ligne Inox se caractérisent par une heureuse combinaison de raffinement dans les lignes et de haute résistance à l'usure et aux agents atmosphériques. Chaque panneau est agrémenté d'inserts en acier inoxydable, pour souligner la recherche de lignes épurées avec des coupes de lumière élégantes. Le design de la ligne Stainless améliore l'esthétique des espaces modernes et soignés, avec des finitions de la large gamme de couleurs RAL.

Modelli
Models
Modèles



ASSIA

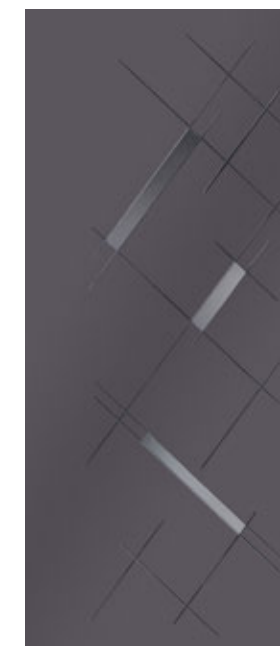

CROMA



DART



DEFEND



EON



ESTREMO

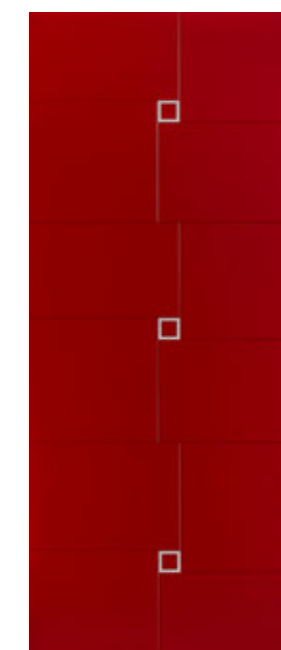

GEMME





LIBERIC



MEDAL



PERLA

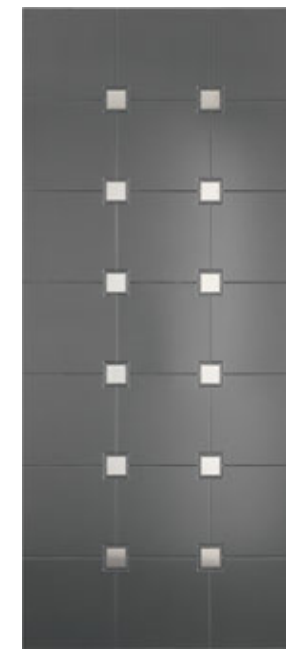

PLATINO

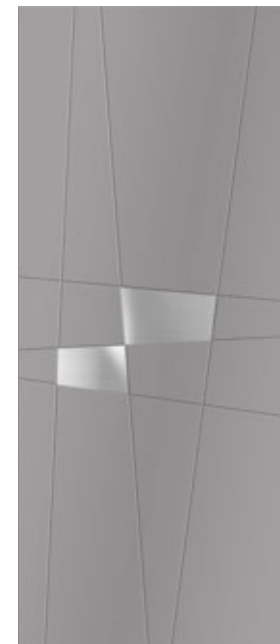

PRESTIGE



QUARZO



REAL



SELENE



SIMPLE



TITANIO

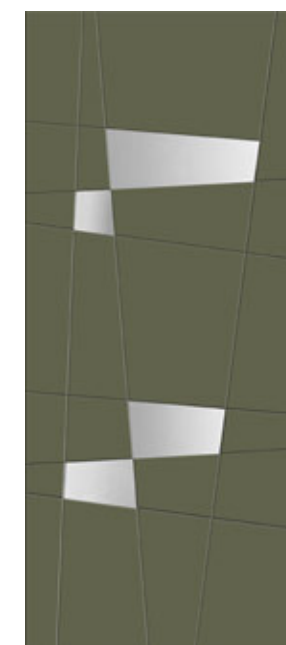

VANITY

AFRODITE



AFRODITE



La porta d'ingresso è un elemento importante per la casa e deve soddisfare fondamentali requisiti tecnici. In particolare la resistenza agli agenti atmosferici è garantita da diversi strati di trattamento dell'ALLUMINIO. Tutte le finiture sono realizzate con impianti all'avanguardia, senza uso di cromo e solventi, che assicurano risultati di altissima qualità ed un ciclo di lavorazione a basso impatto ambientale. I pannelli della linea AFRODITE hanno superato, senza mostrare alcun segno di corrosione, gravosi test di resistenza alla nebbia salina, secondo le modalità dettate dalla norma UNI EN ISO 9227. Una vastissima gamma di modelli, anche con parti vetrate, per assecondare qualsiasi esigenza estetica e funzionale.

The front door is an important element for the home and must meet fundamental technical requirements. In particular, resistance to atmospheric agents is guaranteed by different layers of aluminum treatment. All finishes are made with state-of-the-art systems, without the use of chromium and solvents, which ensure very high quality results and a low environmental impact processing cycle. The panels of the AFRODITE line have passed, without showing any signs of corrosion, severe salt spray resistance tests, according to the procedures dictated by the UNI EN ISO 9227 standard. A very wide range of models, even with glass parts, to satisfy any aesthetic and functional requirement.

La porte d'entrée est un élément important pour la maison et doit répondre à des exigences techniques fondamentales. En particulier, la résistance aux agents atmosphériques est garantie par différentes couches de traitement en aluminium. Toutes les finitions sont réalisées avec des systèmes de pointe, sans l'utilisation de chrome et de solvants, ce qui garantit des résultats de très haute qualité et un cycle de traitement à faible impact environnemental. Les panneaux de la gamme AFRODITE ont passé, sans présenter aucun signe de corrosion, des tests sévères de résistance au brouillard salin, selon les procédures dictées par la norme UNI EN ISO 9227. Une très large gamme de modèles, même avec des parties en verre, pour satisfaire toutes les exigences esthétiques et fonctionnelles.

Per la gamma di colori e finiture consultare pag. 219
For the range of colors and finishes see p. 219
Pour la gamme de couleurs et finitions voir p. 219



Modelli
Models
Modèles



ABACO/K



AGRY/YM



AGUS/Y



AKIRA/Y



ALENO/Y



ALFAIR/K



ALGENIB/KB



ALGENIB_K



ALGENIB/KC

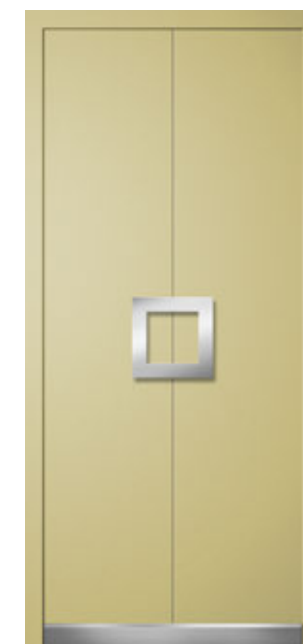

AMBRA/H

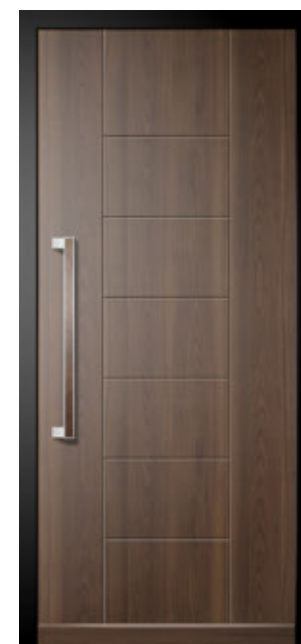

AMBRA/HF



AMBRA/MF



AMBRA/MHB



AMBRA/MHPO



AMBRA/MHSM



ATACAMA/H



ATLAS/W



AURIGA/K



AURIGA/KB

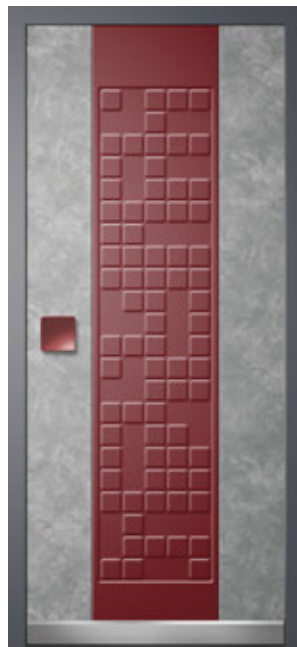

AMBRA/MHTE



ANDROMEDA/K



ANTARES/K



ANTARES/KM



AURIGA/KB1



AURIGA/KC



BASIC/W



BASIC/WD1



ARMIDE/Y



ASTRA/K



ASTRALIS/W



ASTRALIS/WX



BASILEO/K



BELLATRIX/K



BILZEN/Y



BIMOOD/W



BIMOON/WX



BLOG/W



BLOG/W1

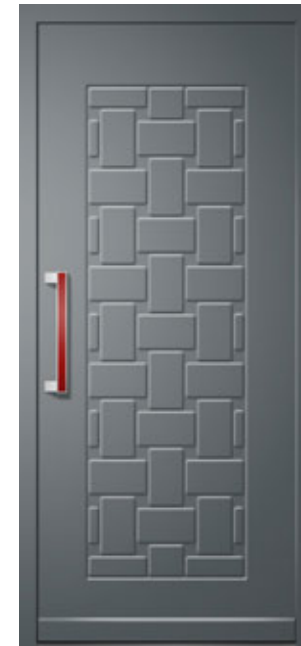

BOTEIN/W



BRILLE/W



BRUNIDE/Y



CAGY/Y



CALT/YB



CARIDE/W



CASER/YM



CASSIOPEA/K



CASSIOPEA/Z



CATANY/Y

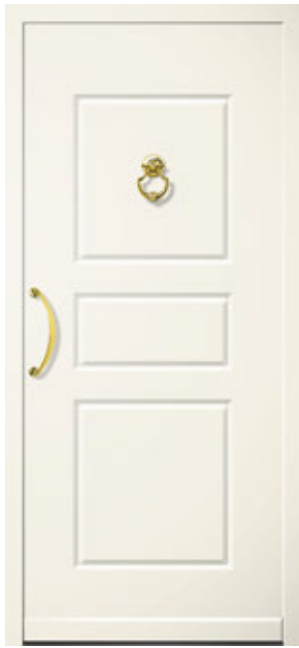

CATANY/YB



CATANY/YM



CHANNEL/W



ECHO/K



ECHO/Z



EGIZY/W



EGIZY/W1



COBALTO/H



CORALLO/F

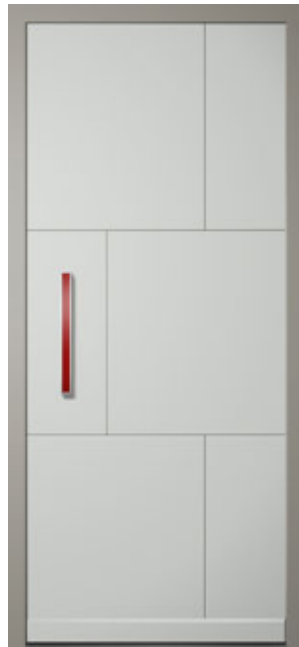

CORALLO/H



DERUTA/K



ELISIR/K



ELISIR/KB



ELISIR/KC



ENNY/Y



DERUTA/KB



DESIRE/W



DIGIT/W



DORADO/K



ENTRY/Y



ERMES/KC



EXAGON/W



EXAGON/WX



EXIT/Y



FLEX/W



FLEX/WB



FLEX/WB1



GENIUS/W



GENIUS/WX



GEO/K



GRADARA/K

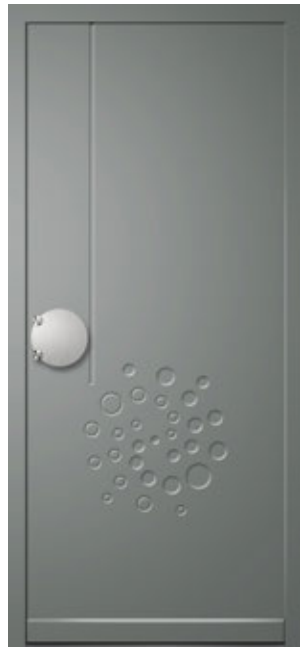

FLOWER/WD



FLOWER/WDX



FOREST/Y



FRISE/W



HELLY/Z



HIDRA/W



HIDRA/WX



IKARO/K



FRISE/WB



FUNNY/W



FUNNY/WX



GALAXY/W

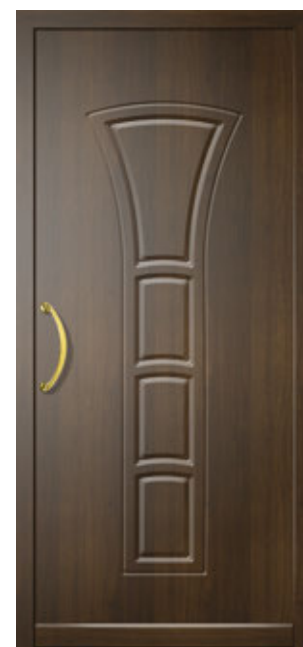

IMPERY/Y



IRIS/K



IRIS/K3



IRIS/Y



JOINT/W



JOINT/WD



JOINT/WDX



JOINT/WX



JOLLY/KBGM



JOLLY/YGM



JOLLY/ZM



KAFFA/Y



KANO/Z



KARDO/Y



KESSEL/Y



KUBO/Z

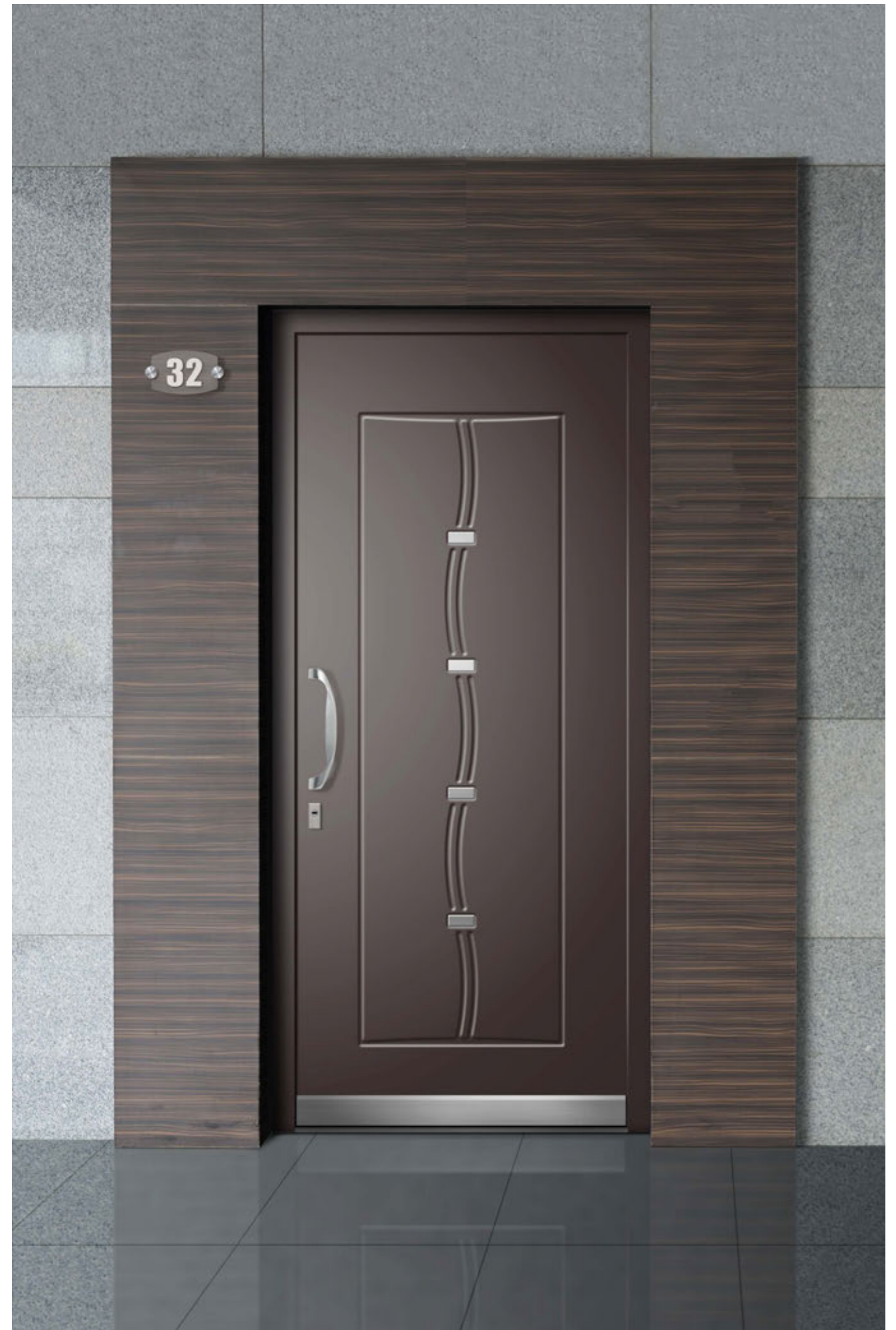



LABIRINT/W



LIBRA/K



LINE/Y



LINE/YB

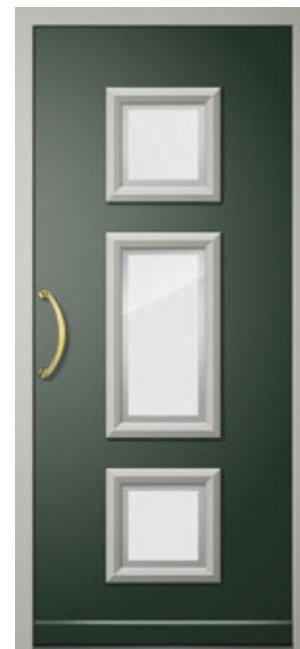

MIRANDA/K3



MIRROR/Z



MIRROR/ZM



MOON/Z



LINE/YC



LODY/Y



MADRAS/WM



MADRAS/WMX



MORAGA/Y



MORESCO/Y



MORESCO/YB



NAOS/Y



MADRAS/WX



MESSY/Y



MINERVA/K



MINTAKA/Y



NASIRA/Y



NICHE/W



NICHE/WX



NYSA/Y



OBLO/Z



OSTY/Y



OVER/Z



OVER/ZM



PALLADIO/K



PALLADIO/K1



PEGASO/KM



PEGASO/KB



PERICLE/Y



PERICLE/YB



PERICLE/YC



PERICLE/YD



PERSEO/K



PERSEO/K1



POINT/W



QUARZO/HE



RIGO/HC



RIGO/HD

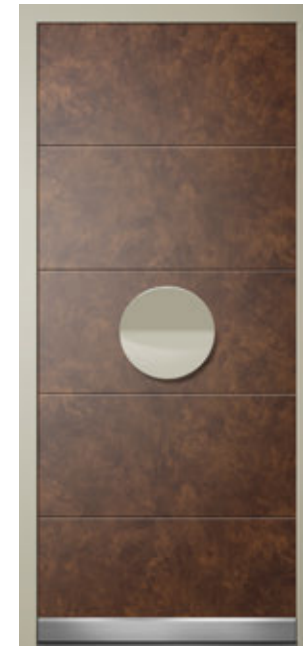

RIGO/HE

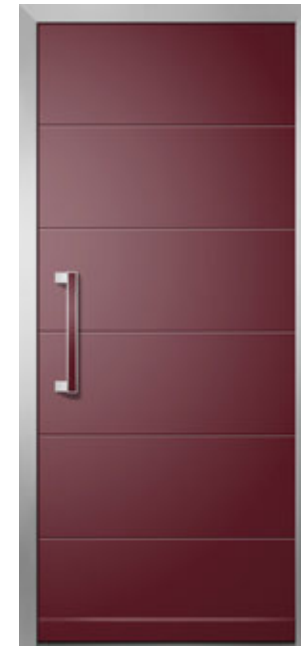

RIGO/HF



QUARZO/HF



QUARZO/MHD



QUATER/K

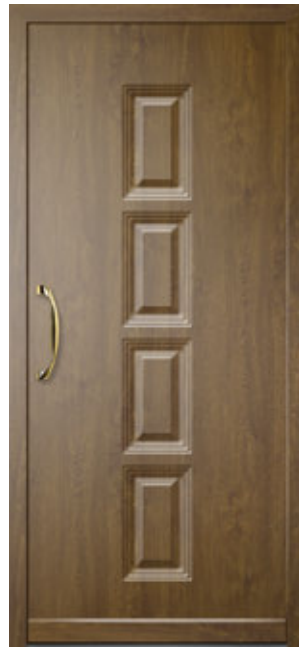

QUATER/KM



RIGO/HG

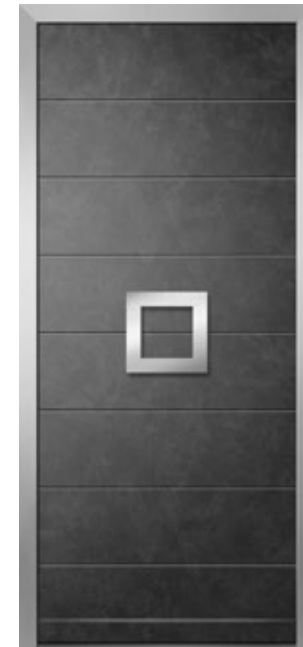

RIGO/HH



ROME/Y



ROTARY/Z



REGOLO/KA

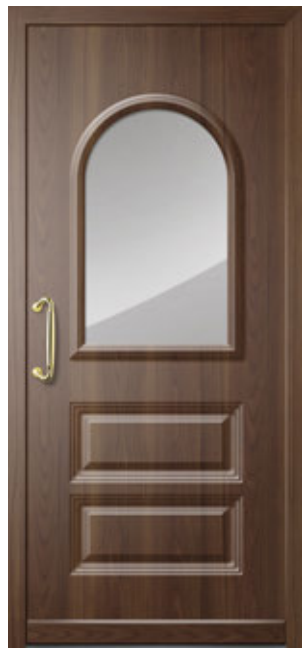

REGOLO/KA1



REGOLO/KD



REGOLO/KD1



SAHARA/H



SANDY/W



SHANGAI/W



SIEN/Y



SIRA/Y

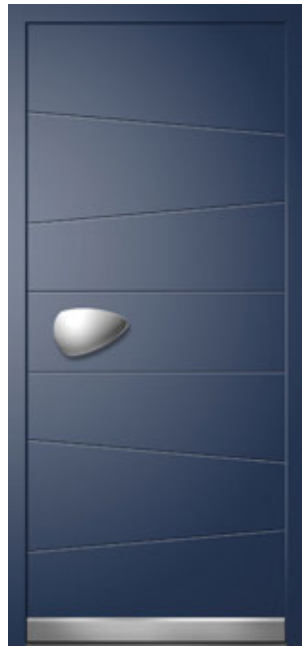

SMERALDO/H



SMOKY/W



SOFFY/W



SPIGA/YG



STONE/WD



STONE/WDX



STREAM/W



SOFFY/WX



SPACE/W



SPIGA/YA



SPIGA/YB



STRIP/W



STRIP/W1



STRIP/WM



STRIP/WMX



SPIGA/YC



SPIGA/YD



SPIGA/YE



SPIGA/YF



SUBRA/Y



SUBRA/YB



SUBRA/YC



SUNRAY/Z



TABLET/Y



TACOBO/Y



TAOR/Y

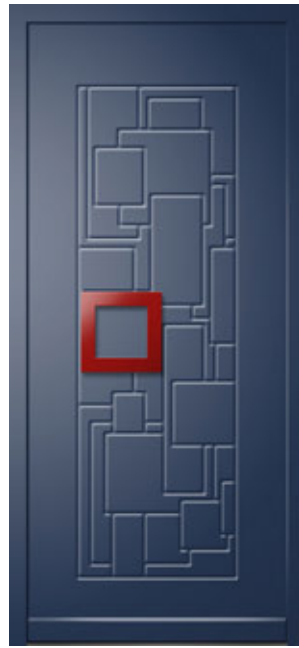

TARIS/Y

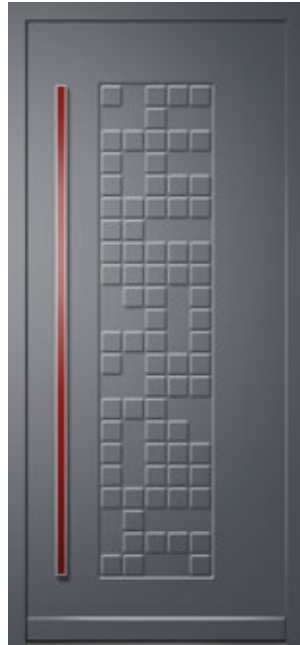

TETRIS/W



TIFFANY/Y



TOPAZIO/FD



TOPAZIO/HD

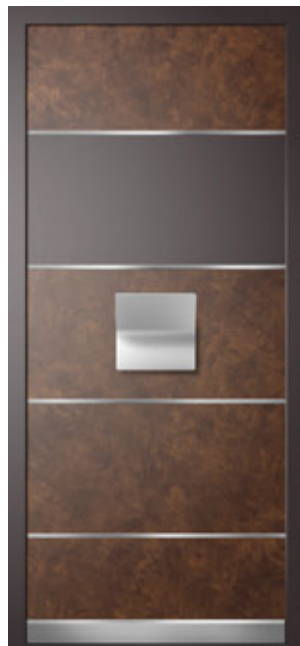

TOPAZIO/MFB



TOPAZIO/MFE

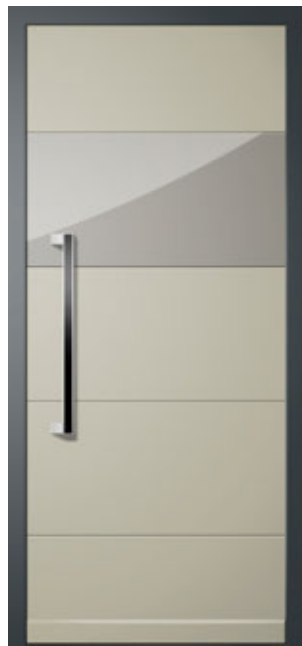

TOPAZIO/MHB



TOPAZIO/MHC





TOPAZIO/MHE



TRIADE/K



TRIADE/KB



TRIADE/KBM



WOOD/W



ZAFFIRO/FB



ZAFFIRO/FC



ZAFFIRO/HB



TRIADE/KC



TRIANGOLO/Z



TRILOGY/W



TRILOGY/WX



ZAFFIRO/HC



ZAFFIRO/HD



ZAFFIRO/HE

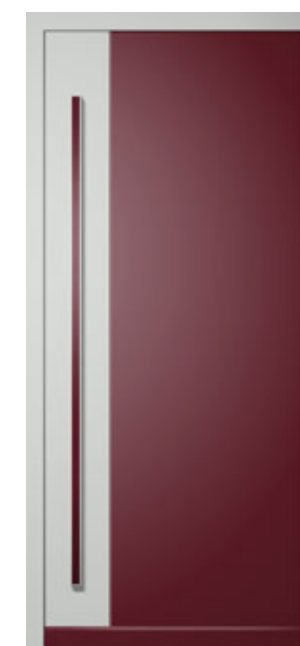

ZAFFIRO/MH



URBIS/Y



VINTAGE/W



WADIRUM/H



WIND/W

Pomoli, battenti, maniglioni e maniglie

Pomoli Knobs Boutons

York

LxH 59,5x59,5 mm

Cromo satinato



Wing

LxH 50x50 mm

Cromo lucido



GM

Ø 75 mm

Ottone lucido



Susy

Ø 59 mm

Ottone lucido



Universal

Ø 70 mm

Anodizzato bronzo



Battenti Knockers Heurtoir

Anello

LxH 136x154 mm

Ottone lucido verniciato



Leone

LxH 115x193 mm

Ottone lucido verniciato



Maniglioni Pull Handles Poignées

York Diritto

H 250 mm

Cromo satinato



York a C

H 320 mm

Cromo satinato



Euclide

(Ø 25 H 500/600 mm)

Cromo lucido/satinato



Sogno

H 220 mm

Cromo satinato



Modulare

H 400-500-1000-1700 mm

Cromo satinato



Quadro

(LxL 25x25 H 500/600 mm)

Cromo satinato



Tondo

(Ø 25 H 500/600 mm)

Cromo satinato



Cometa

H 220 mm

Ottone lucido verniciato



Airone

H 220 mm

Ottone lucido verniciato

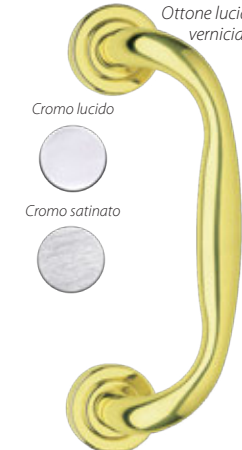

Steel 101

H 270 mm

Inox



Steel 102

H 500 mm

Inox



Steel 109

H 463 mm

Inox



















Steel 113









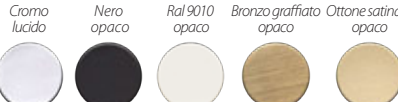



H 325 mm

Inox



maniglie
handless
poignées

<p>Giove</p> <p>Alluminio cromo satinato</p> 	<p>GM07</p> <p>Cromo Lucido</p>  <p>Cromo satinato</p> 	<p>Toy</p> <p>Cromo Satinato</p>  <p>Cromo lucido Nero opaco Ral 9010 opaco Bronzo graffiato opaco Ottone satinato opaco</p> 
<p>York</p> <p>Cromo satinato</p>  <p>Cromo lucido Nero opaco</p> 	<p>Rialto</p> <p>Cromo satinato</p>  <p>Cromo lucido Nero opaco</p> 	<p>Cartesio Q</p> <p>Cromo lucido/satinato</p> 
<p>Cartesio Q B/W</p> <p>Cromo lucido/Nero opaco</p>  <p>Cromo lucido bianco</p> 	<p>Wing</p> <p>Cromo satinato</p>  <p>Cromo lucido</p> 	<p>Atlanta</p> <p>Cromo satinato</p>  <p>Cromo lucido Bronzo Yester Bianco Monviso Nero Etna</p> 
<p>Baar</p> <p>Nero Etna</p>  <p>Cromo lucido Bronzo Yester Bianco Monviso Cromo satinato</p> 	<p>Pepe</p> <p>Bronzo Yester</p>  <p>Cromo lucido Cromo satinato Bianco Monviso Nero Etna</p> 	<p>Pure</p> <p>Cromo lucido</p>  <p>Bianco Monviso Bronzo Yester Cromo satinato Nero Etna</p> 
<p>Galileo</p> <p>Cromo lucido/satinato</p> 	<p>Linea</p> <p>Titanium</p>  <p>Cromo lucido Nero opaco</p> 	<p>Nion</p> <p>Cromo satinato</p>  <p>Cromo lucido Nero opaco Ral 9010 opaco Bronzo graffiato opaco Ottone satinato opaco</p> 

<p>Leaf</p> <p>Cromo lucido</p>  <p>Cromo satinato Nero opaco</p> 	<p>Farfalla</p> <p>Cromo lucido</p>  <p>Cromo satinato Nero opaco Titanium</p> 	<p>Uno</p> <p>Cromo Satinato</p>  <p>Ottone lucido</p> 
<p>Shark</p> <p>Cromo satinato</p>  <p>Cromo lucido Ottone lucido</p> 	<p>Milena</p> <p>Cromo satinato</p> 	<p>Luna</p> <p>Alluminio cromo satinato</p> 
<p>Novecento</p> <p>Ottone anticato naturale</p>  <p>Ottone ferro antico Ottone lucido verniciato Ottone brunito</p> 	<p>Victoria</p> <p>Ottone lucido</p> 	

Maniglioni
Pull Handles
Poignées

A 951
H 400 mm



Acciaio inox Ins. RAL 3003 Grinz Ins. RAL 9005 Grinz Ins. CORTEN RP101M

A 961
H 400 mm



Acciaio inox Ins. RAL 3003 Grinz Ins. RAL 9005 Grinz Ins. CORTEN RP101M

A 971
H 400 mm



Acciaio inox Ins. RAL 3003 Grinz Ins. RAL 9005 Grinz Ins. CORTEN RP101M

A 941
LxH 280x280 mm

Acciaio inox



 
RAL 3003 Grinz RAL 9005 Grinz

A 942
LxH 280x273 mm

Acciaio inox



 
RAL 3003 Grinz RAL 9005 Grinz

A 943
LxH 330x321 mm

Acciaio inox



 
RAL 3003 Grinz RAL 9005 Grinz

A 944
LxH 255x160 mm

Acciaio inox



 
RAL 3003 Grinz RAL 9005 Grinz

A 945
LxH 120x120 mm

Acciaio inox

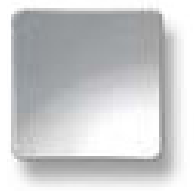

 
RAL 3003 Grinz RAL 9005 Grinz

A 946
LxH 160x160 mm

Acciaio inox



 
RAL 3003 Grinz RAL 9005 Grinz

A 406 - A 506
LxH 80x295 mm

Cromo satinato A 506



Oro PDV A 406



A 307 - A 407 - A 507
LxH 95x316 mm

Cromo satinato A 507



Oro PDV A 407 Bronzo A 307



A 408 - A 508
LxH 60x266 mm

Cromo satinato A 508



Oro PDV A 408



A 309 - A 409 - A 509
LxH 80x320 mm

Cromo satinato A 509



Oro PDV A 409 Bronzo A 309



A 314 - A 414 - A 514
LxH 90x336 mm

Cromo satinato A 514



Oro PDV A 414 Bronzo A 314



A 415 - A 515
LxH 90x315 mm

Cromo satinato A 515



Oro PDV A 415



A 316 - A 416 - A 516
LxH 90x307 mm

Cromo satinato A 516



Oro PDV A 416 Bronzo A 316



A 417 - A 517
LxH 90x309 mm

Cromo satinato A 517



Oro PDV A 417



A 318 - A 418 - A 518
LxH 65x313 mm

Cromo satinato A 518



Oro PDV A 418 Bronzo A 318



A 370 - A 470 - A 570
LxH 94x340 mm

Cromo satinato A 570



Oro PDV A 470 Bronzo A 370



A 613
LxH 95x333 mm

Acciaio inox



A 616
LxH 90x306 mm

Acciaio inox



A 618
LxH 126x387 mm

Acciaio inox



A 619
LxH 32x560 mm

Acciaio inox



Maniglioni
Pull Handles
Poignées

A 621
LxH 74x400 mm

Acciaio inox



A 622
LxH 74x600 mm

Acciaio inox



A 623
LxH 74x1000 mm

Acciaio inox



A 624
LxH 86x1700 mm

Acciaio inox



A 705
LxH 105x700 mm

Acciaio inox



A 625
LxH 86x900 mm

Acciaio inox



A 680
LxH 157x420 mm

Acciaio inox



A 682
LxH 212x372 mm

Acciaio inox



A 683
LxH 174x300 mm

Acciaio inox



A 685
LxH 194x200 mm

Acciaio inox



A 686
LxH 217x200 mm

Acciaio inox



A 687
LxH 217x200 mm

Acciaio inox



A 688
LxH 217x200 mm

Acciaio inox



A 689
LxH 194x200 mm

Acciaio inox



A 691
LxH 117x420 mm

Acciaio inox



A 692
LxH 212x372 mm

Acciaio inox



A 693
LxH 162x470 mm

Acciaio inox



A 700
LxH 120x610 mm

Acciaio inox



A 701
LxH 76x400 mm

Acciaio inox



A 702
LxH 76x600 mm

Acciaio inox



A 703
LxH 76x1000 mm

Acciaio inox



Manigliera di serie
Handles standard
Poignées standard

Alluminio Bronzo



Alluminio Ottone Lucido



Alluminio Argento



Bocchetta e defender in acciaio con cover in alluminio
Nozzle and defender steel with aluminum cover
Buse et de l'acier de défenseur avec couvercle en aluminium



Alluminio Bronzo



Alluminio Argento



Alluminio Ottone Lucido



Spioncino digitale (opzionale)
Digital peephole (optional)
Judas digital (optionnel)



Manigliera Quadra (opzionale)
Handles Quadra (optional)
Poignées Quadra (optionnel)



Cilindri

ISEO R6



Caratteristiche del cilindro rispetto alla norma Uni En 1303:2005

	Gradi di classificazione	Classificazione
Categoria d'uso	1/2/3	1 (porte residenziali)*
Durata	4/5/6	6 (100.000 cicli)
Resistenza al fuoco	0/1	1 (adatta)
Resistenza corrosione e temperatura	0/A/B/C	C (altissima resistenza)
Sicurezza relativa alla chiave	1-6	5 (50.000 combinazioni con 5 perni)
Resistenza all'attacco	0/1/2	2 (5-10 minuti di resistenza alla foratura)

- Cilindro europeo di sicurezza Iseo R6
- 5 chiavi con volantino interno
- chiave da cantiere

DOM IX 6 SR



Caratteristiche del cilindro rispetto alla norma Uni En 1303:2005

	Gradi di classificazione	Classificazione
Categoria d'uso	1/2/3	1 (porte residenziali)*
Durata	4/5/6	6 (100.000 cicli)
Resistenza al fuoco	0/1	0 (non adatta)
Resistenza corrosione e temperatura	0/A/B/C	C (resistenza alla corrosione e resistenza alla temperatura -20 +80)
Sicurezza relativa alla chiave	1-6	6 (100.000 combinazioni con 6 perni)
Resistenza all'attacco	0/1/2	2 (5-10 minuti di resistenza alla foratura)

- Cilindro europeo di altissima sicurezza Dom IX6 SR
- 5 chiavi
- chiave da cantiere (duplicazione chiavi controllata)

CISA Astral Tekno



Caratteristiche del cilindro rispetto alla norma Uni En 1303:2005

	Gradi di classificazione	Classificazione
Categoria d'uso	1/2/3	1 (porte residenziali)*
Durata	4/5/6	6 (100.000 cicli)
Resistenza al fuoco	0/1	1 (adatta)
Resistenza corrosione e temperatura	0/A/B/C	C (resistenza alla corrosione e resistenza alla temperatura -20 +80)
Sicurezza relativa alla chiave	1-6	6 (100.000 combinazioni con 6 perni)
Resistenza all'attacco	0/1/2	1 (3-5 minuti di resistenza alla foratura)

- Cilindro europeo di sicurezza Cisa Astral Tekno
- 5 chiavi con volantino interno (duplicazione chiavi controllata)

SECUREMME SERRATURE DI SICUREZZA EVO K64



Caratteristiche del cilindro

- Cilindro di altissima sicurezza con doppio sistema di cifratura meccanico a 11 perni e pista a 4 elementi mobili attivi
- Numero di combinazioni > di 4,5 milioni
- Spine anti-trapano, presenti nello statore e nel rotore
- PIN UNICO anti-bump
- Sistema cambio cifratura
- Cam DIN 30° (C, P, Q)
- Finitura cromo satinata
- Chiavi in alpacca
- Chiave a duplicazione protetta
- Esecuzioni speciali: KA - CA - TANDEM
- Tipologia disponibile: **C** chiave-chiave **M** mezzo cilindro **Q** predisposto al pomolo-chiave

- Cilindro europeo di sicurezza Securemme Evo K64
- 5 chiavi con volantino interno
- chiave da cantiere

Cilindro con volantino



Campionario riepilogativo essenze e finiture

Utile strumento per una consultazione veloce delle essenze e delle finiture per tutte le linee di porte interne e porte blindate presentate in questo catalogo. Al momento dell'ordine Vi preghiamo di utilizzare i campioni reali disponibili presso il Vs rivenditore di fiducia. I colori e le finiture qui riportate sono puramente indicativi.

Useful instrument for a rapid consultation of the available woods for all the lines of internal and security doors presented in this catalogue. At the time of the order, we ask you to use the real samples available at your trusted sales outlet. The colours and finishes contained herein are purely indicative.

Instrument utile pour une consultation rapide des essences de bois disponibles pour toutes les lignes de portes internes et de portes blindées présentées dans ce catalogue. Au moment de la commande, nous vous prions d'utiliser les échantillons réels disponibles chez votre revendeur de confiance. Les couleurs et les finitions indiquées ici sont purement indicatives.

Laminati VENTIVENTI
Laminated VENTIVENTI
Laminé VENTIVENTI

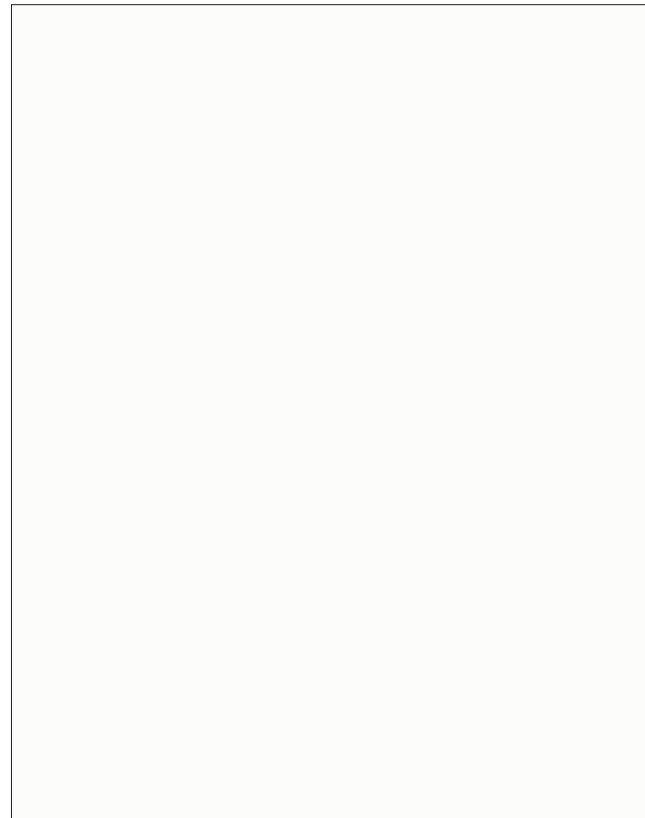

Latte



Gesso



Piuma

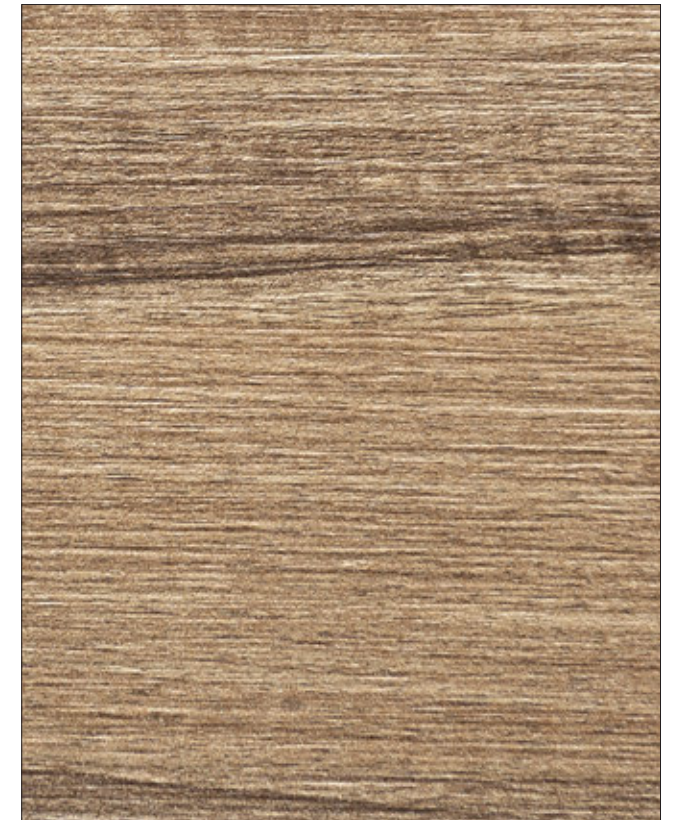

Sandalo



Calce



Corda

Laminati Ready Doors
Laminated Ready Doors
Laminé Ready Doors

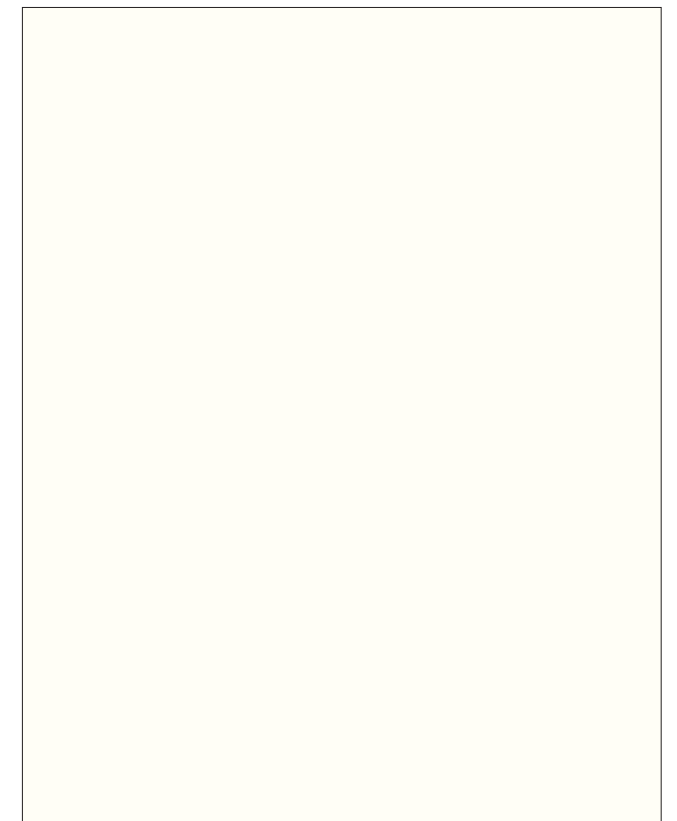

Bianco opaco

Verificare su mazzetta i colori reali. Sul sito www.otcdoors.com il pdf del catalogo per una miglior visualizzazione delle immagini.
Check the real colors on the fan. On the website www.otcdoors.com the pdf of the catalog for a better visualization of the images.
Vérifiez les vraies couleurs sur le ventilateur. Sur le site www.otcdoors.com le pdf du catalogue pour une meilleure visualisation des images.

Laminati Ready Doors
Laminated Ready Doors
Laminé Ready Doors



Olmo bianco



Olmo grigio



Olmo nocciola



Palissandro bianco

Essenze
Essences
Essences



Castagno Decò L1
Decò L1 Chestnut
Châtaigne Decò L1



Castagno Decò L2
Decò L2 Chestnut
Châtaigne Decò L2

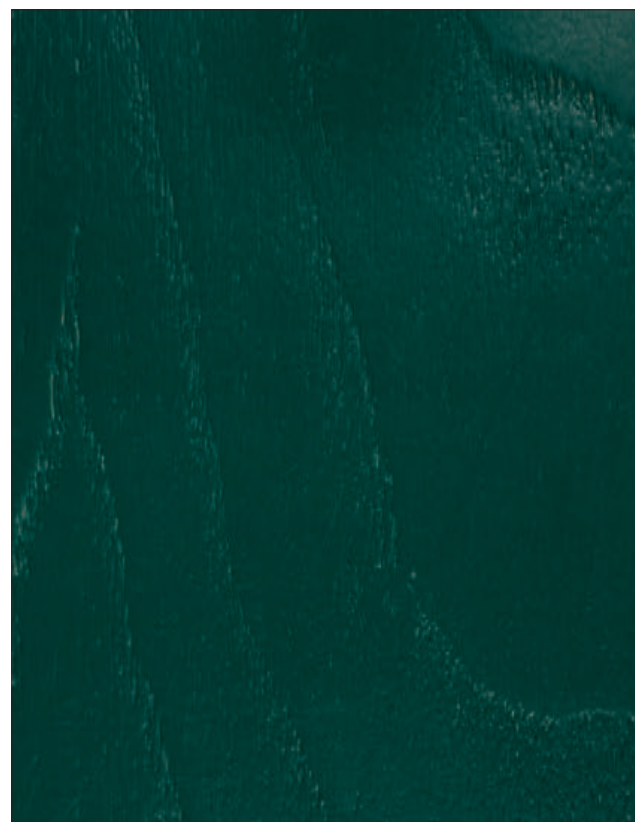

Castagno Laccato a Poro aperto RAL 6005
Open Pore Lacquered RAL 6005 Chestnut
Châtaigne Laqué Pore ouvert RAL 6005

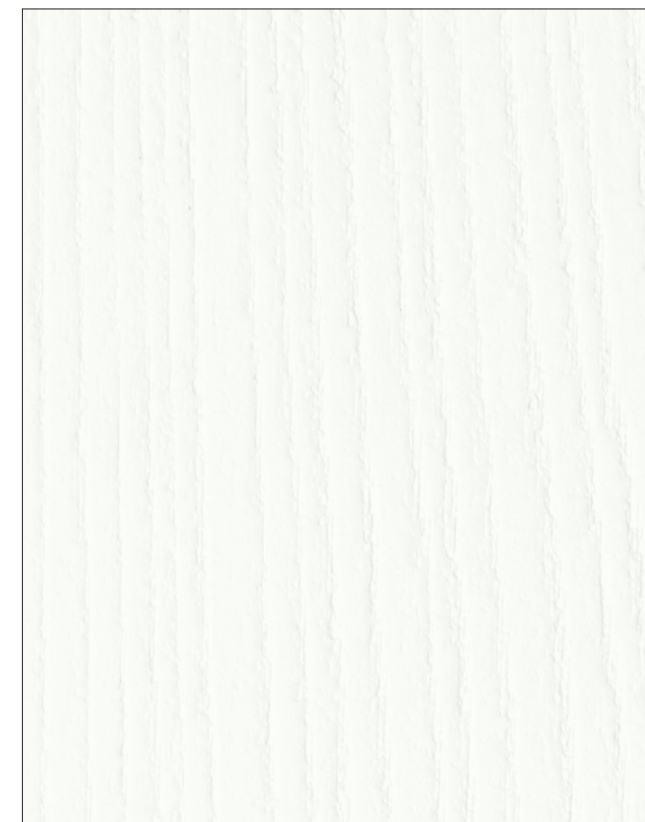

Castagno Sabbiato Laccato RAL 9003
Chestnut sandblasted lacquered RAL 9003
Châtaigne sablé laqué RAL 9003

Verificare su mazzetta i colori reali. Sul sito www.otcdoors.com il pdf del catalogo per una miglior visualizzazione delle immagini.
Check the real colors on the fan. On the website www.otcdoors.com the pdf of the catalog for a better visualization of the images.
Vérifiez les vraies couleurs sur le ventilateur. Sur le site www.otcdoors.com le pdf du catalogue pour une meilleure visualisation des images.

Essenze
Essences
Essences



Castagno Tinto Medio
Chestnut Dyed Medium
Châtaigne Teinté Moyenne



Castagno Tinto Scuro
Walnut Dyed Dark
Châtaigne Teinté Sombre

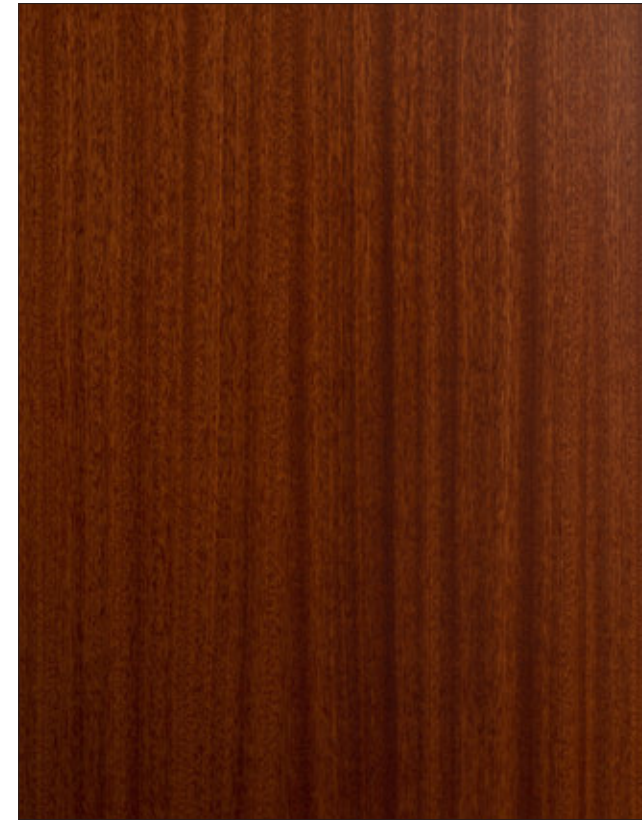

Mogano Tinto Chiaro
Mahogany Dyed Clear
Acajou Teinté Clair

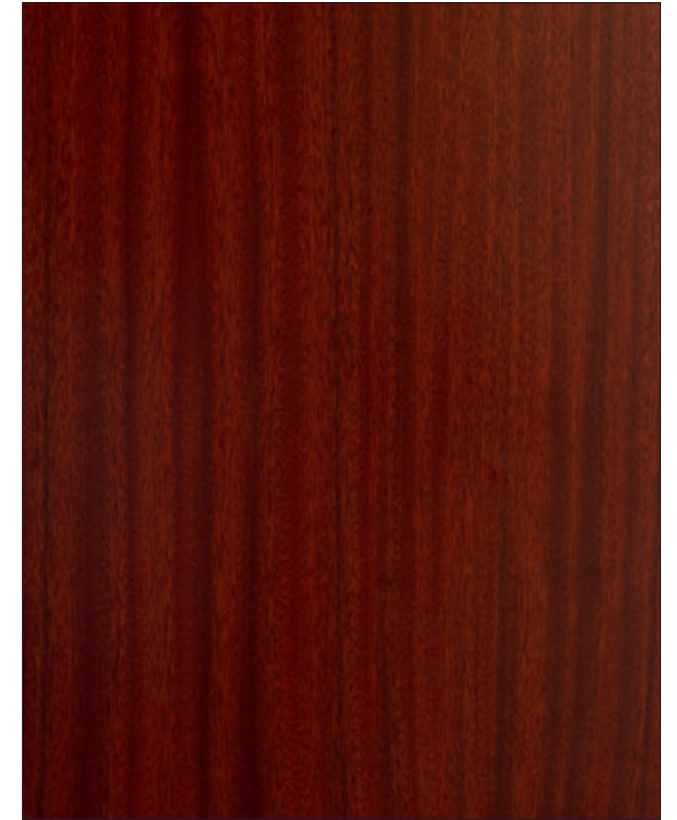

Mogano Tinto Medio
Mahogany Dyed Medium
Acajou Teinté Moyenne



Frassino Laccato Poro aperto RAL 3004
Ash lacquered open pore RAL 3004
Frêne laqué à pores ouverts RAL 3004



Frassino Tinto Medio
Ash Dyed Medium
Frêne Teinté Moyenne



Noce Nazionale Tinto Medio
Italian Walnut Dyed Medium
Noyer Italien Teinté Moyenne



Tanganica Laccato RAL 9003
Tanganica Lacquered RAL 9003
Tanganica Laqué RAL 9003

Verificare su mazzetta i colori reali. Sul sito www.otcdoors.com il pdf del catalogo per una miglior visualizzazione delle immagini.
Check the real colors on the fan. On the website www.otcdoors.com the pdf of the catalog for a better visualization of the images.
Vérifiez les vraies couleurs sur le ventilateur. Sur le site www.otcdoors.com le pdf du catalogue pour une meilleure visualisation des images.

Essenze
Essences
Essences



Okumè Tinto Chiaro
Okumè Dyed Clear
Okumè Teinté Clair

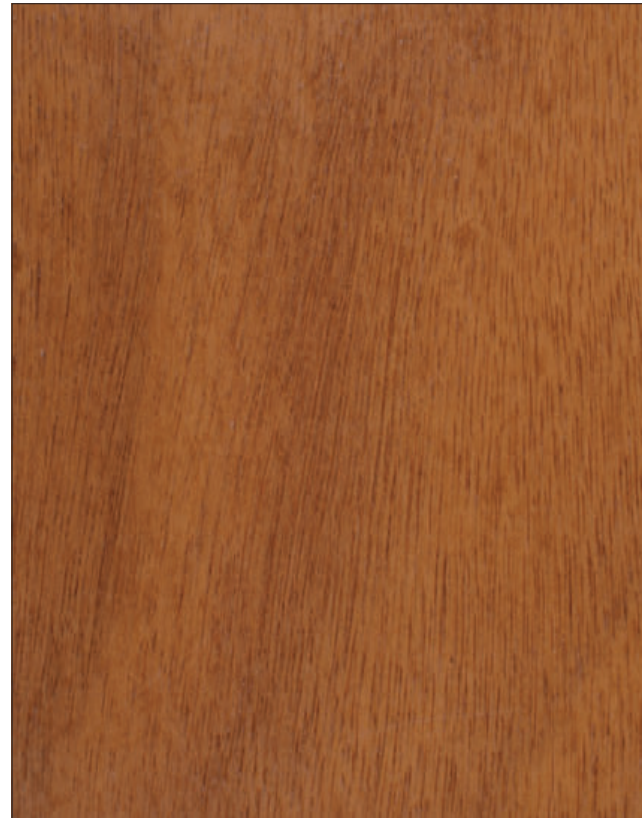

Okumè Tinto Ciliegio
Okumè Dyed Cherry
Okumè Teinté Cerise



Rovere Naturale
Natural Oak
Chêne Naturel



Rovere Tinto Medio
Oak Dyed Medium
Chêne Teinté Moyenne



Okumè Tinto Medio
Okumè Dyed Medium
Okumè Teinté Moyenne



Okumè Tinto Verde
Okumè Dyed Green
Okumè Teinté Vert



Rovere Tinto Miele
Oak Dyed Honey
Chêne Teinté Miel



Rovere Tabacco
Oak Tobacco
Chêne Tabac

Verificare su mazzetta i colori reali. Sul sito www.otcdoors.com il pdf del catalogo per una miglior visualizzazione delle immagini.
Check the real colors on the fan. On the website www.otcdoors.com the pdf of the catalog for a better visualization of the images.
Vérifiez les vraies couleurs sur le ventilateur. Sur le site www.otcdoors.com le pdf du catalogue pour une meilleure visualisation des images.

Essenze
Essences
Essences

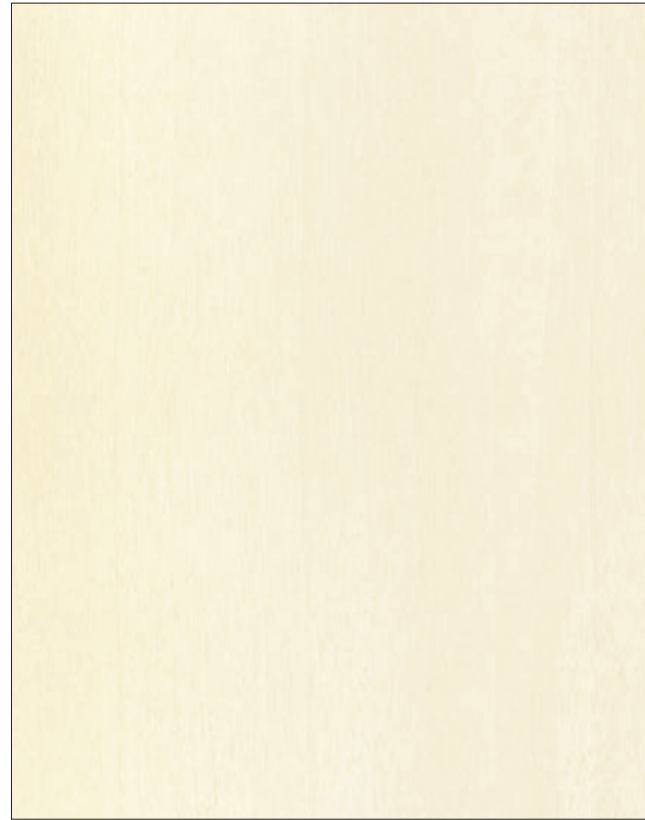

Tanganica Laccato RAL 9001
Tanganika Lacquered 9001
Tanganika Laqué 9001

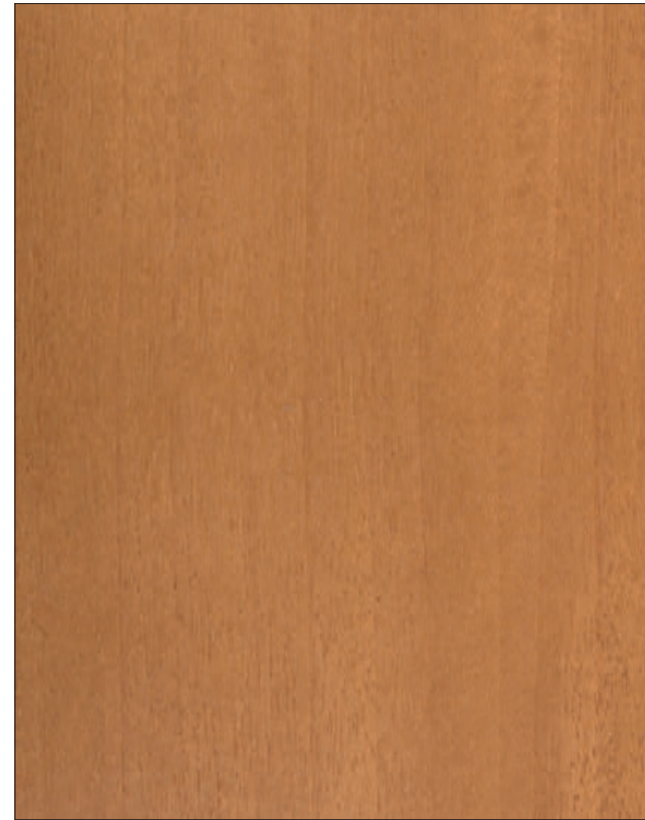

Tanganica Tinto Chiaro
Tanganyika Dyed Clear
Tanganyika Teinté Clair



Tanganica Tonalizzato Naturale
Tanganyika Natural Colour-enhancing
Tanganyika teint naturel

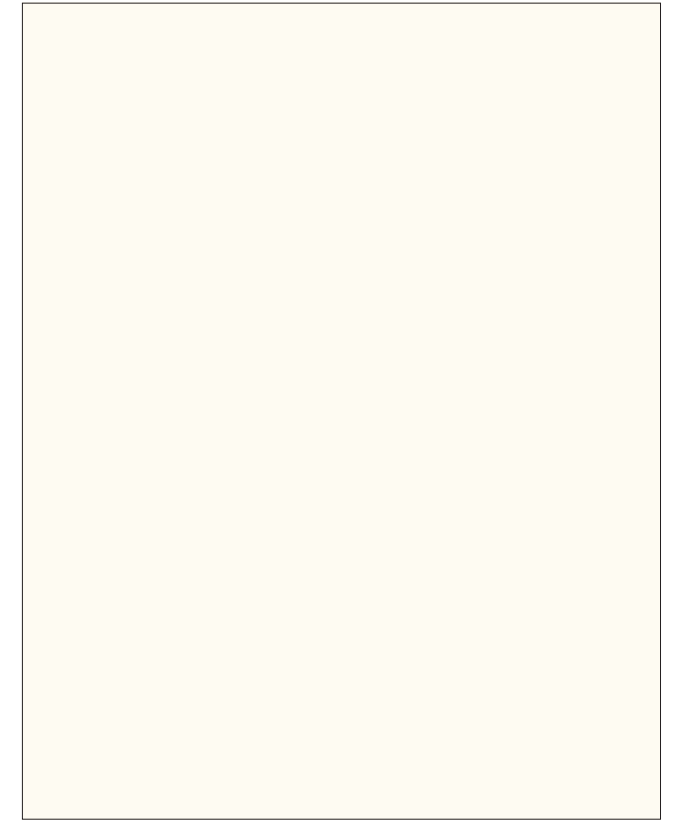

Toulipier Laccato RAL 9010
Toulipier lacquered RAL 9010
Toulipier laqué RAL 9010



Tanganica Tinto Ciliegio
Tanganika Dyed Cherry
Tanganika Teinté Cerise



Tanganica Tinto Medio
Tanganika Dyed Medium
Tanganika Teinté Moyenne



Toulipier Tinto Chiaro
Toulipier Dyed Clear
Toulipier Teinté Clair



Toulipier Tinto Ciliegio
Toulipier Dyed Cherry
Toulipier Teinté Cerise

Verificare su mazzetta i colori reali. Sul sito www.otcdoors.com il pdf del catalogo per una miglior visualizzazione delle immagini.
Check the real colors on the fan. On the website www.otcdoors.com the pdf of the catalog for a better visualization of the images.
Vérifiez les vraies couleurs sur le ventilateur. Sur le site www.otcdoors.com le pdf du catalogue pour une meilleure visualisation des images.

Essenze
Essences
Essences



Toulipier Tinto Medio
Toulipier Dyed Medium
Toulipier Teinté Moyenne



Yellow Pine Tinto Chiaro
Yellow Pine Dyed Clear
Yellow Pine Teinté Clair



Yellow Pine Tinto Medio
Yellow Pine Dyed Medium
Yellow Pine Teinté Moyenne



Yellow Pine Tinto Verde
Yellow Pine Dyed Green
Yellow Pine Teinté Vert

Verificare su mazzetta i colori reali. Sul sito www.otcdoors.com il pdf del catalogo per una miglior visualizzazione delle immagini.
 Check the real colors on the fan. On the website www.otcdoors.com the pdf of the catalog for a better visualization of the images.
 Vérifiez les vraies couleurs sur le ventilateur. Sur le site www.otcdoors.com le pdf du catalogue pour une meilleure visualisation des images.

Laccati
Lacquered
Laqué

Decò - Finiture eseguite a mano
 Decò - Hand-made finishes
 Decò - Finitions à la main



p1



p2



p3



p4

Laccati
Lacquered
Laqué



p5



p6

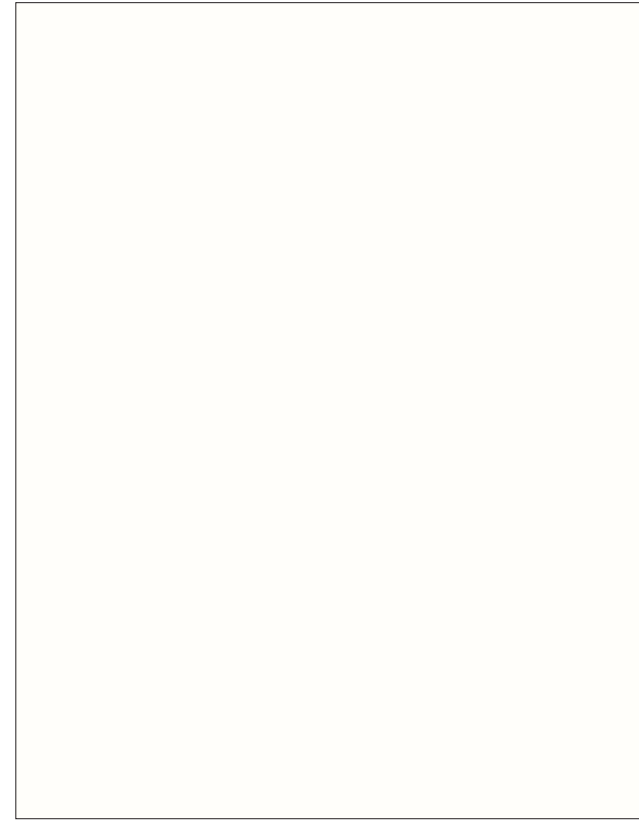

RAL 9003

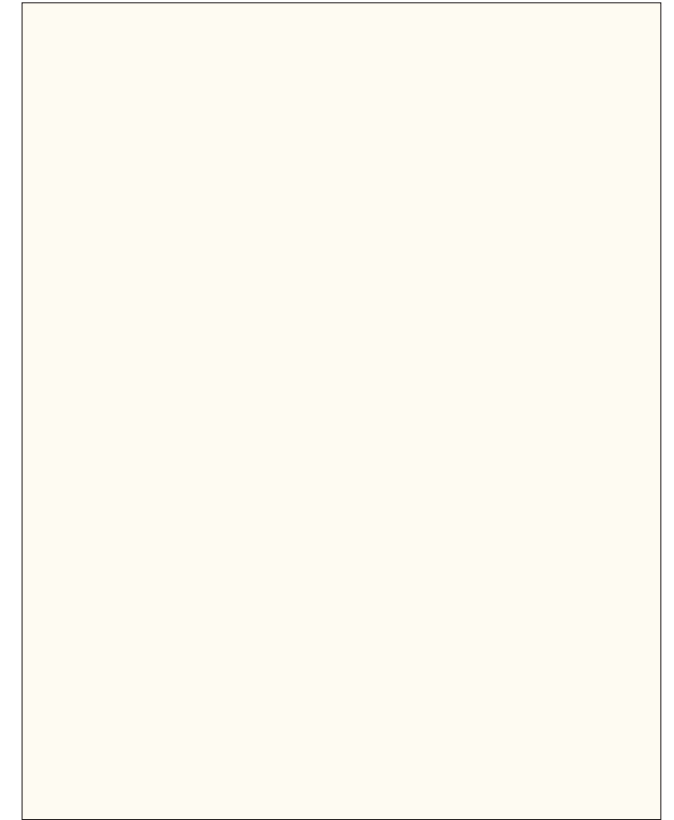

RAL 9010

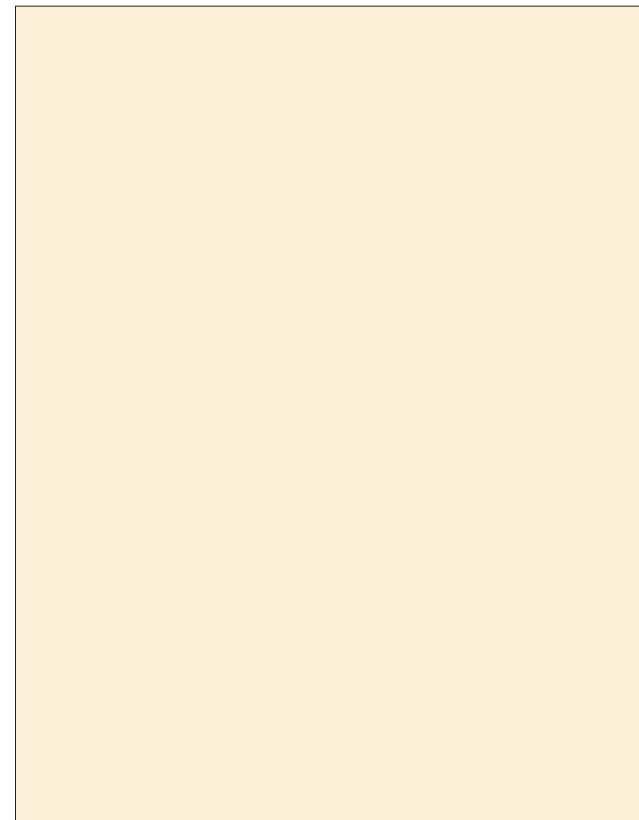

RAL 9001

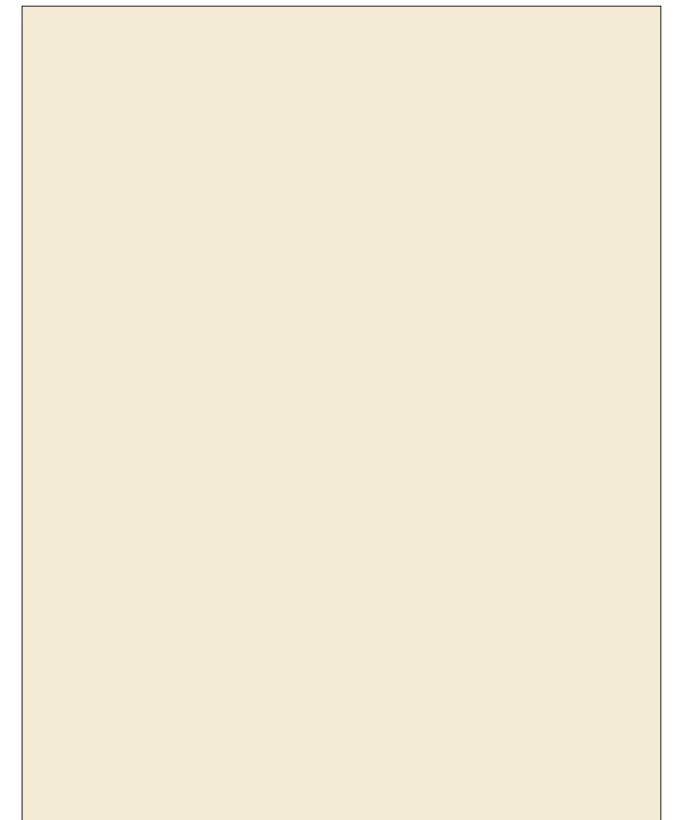

RAL 1013

Laccati
Lacquered
Laqué

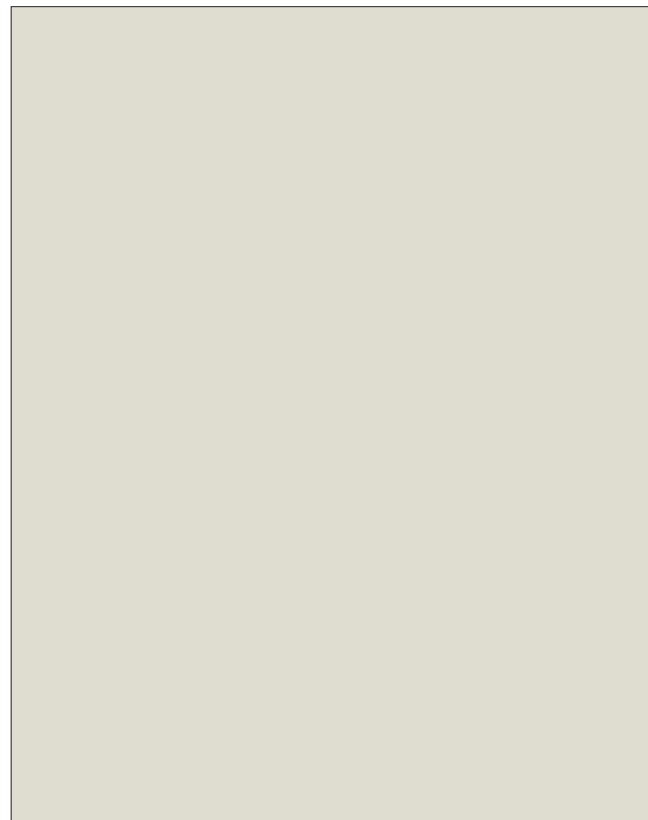

RAL 9002

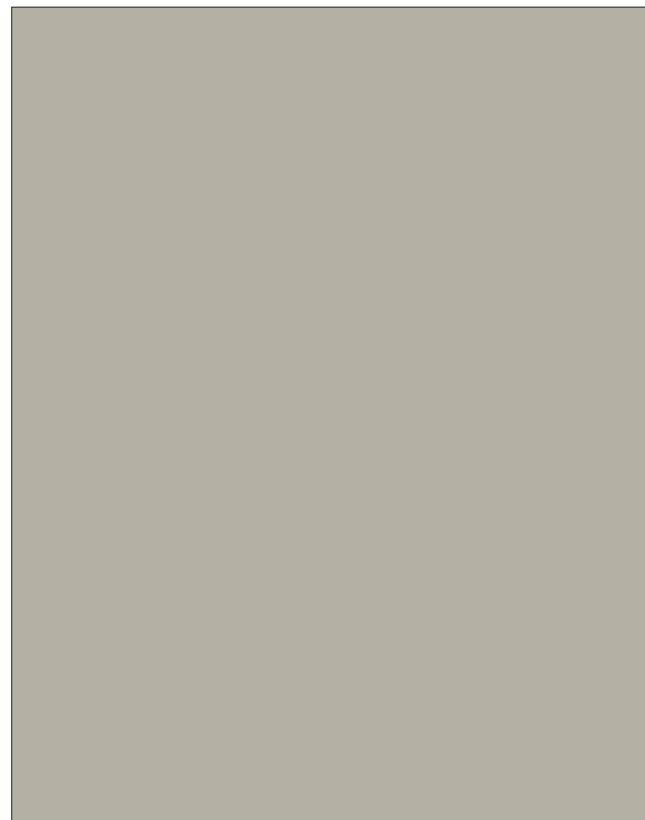

RAL 7044



RAL 6021



RAL 6005



RAL 7005



RAL 3004



RAL 5001



RAL 8019

Verificare su mazzetta i colori reali. Sul sito www.otcdoors.com il pdf del catalogo per una miglior visualizzazione delle immagini.
Check the real colors on the fan. On the website www.otcdoors.com the pdf of the catalog for a better visualization of the images.
Vérifiez les vraies couleurs sur le ventilateur. Sur le site www.otcdoors.com le pdf du catalogue pour une meilleure visualisation des images.

Laccati
Lacquered
Laqué

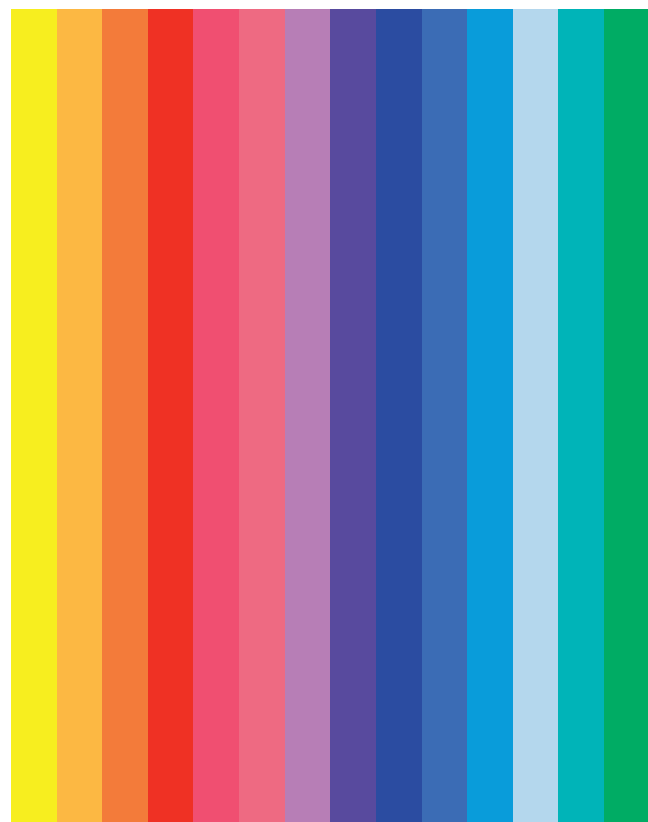

RAL

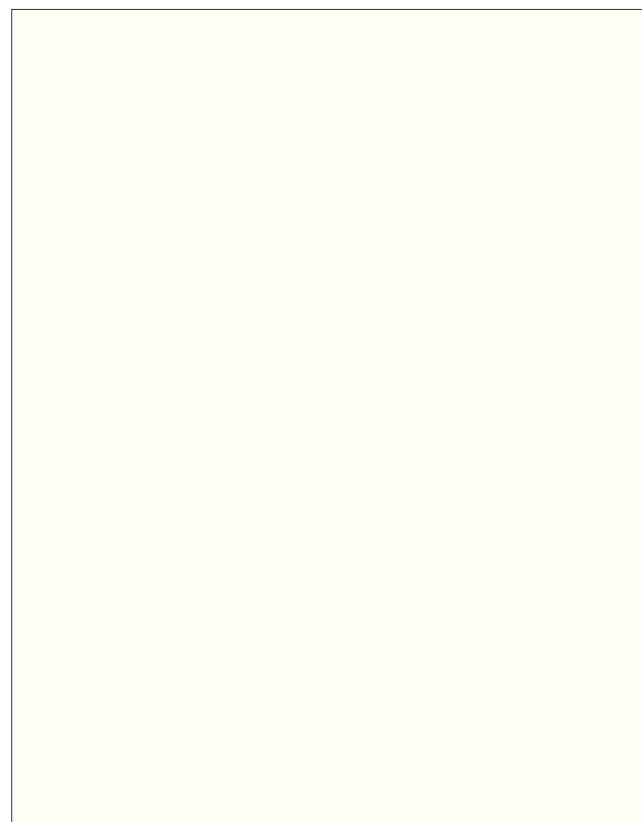

Finitura opaca (di serie)
Matte finish (standard)
Finition mate (standard)



Finitura lucida (opzionale)
Glossy finish (optional)
Finition brillante (sur demande)

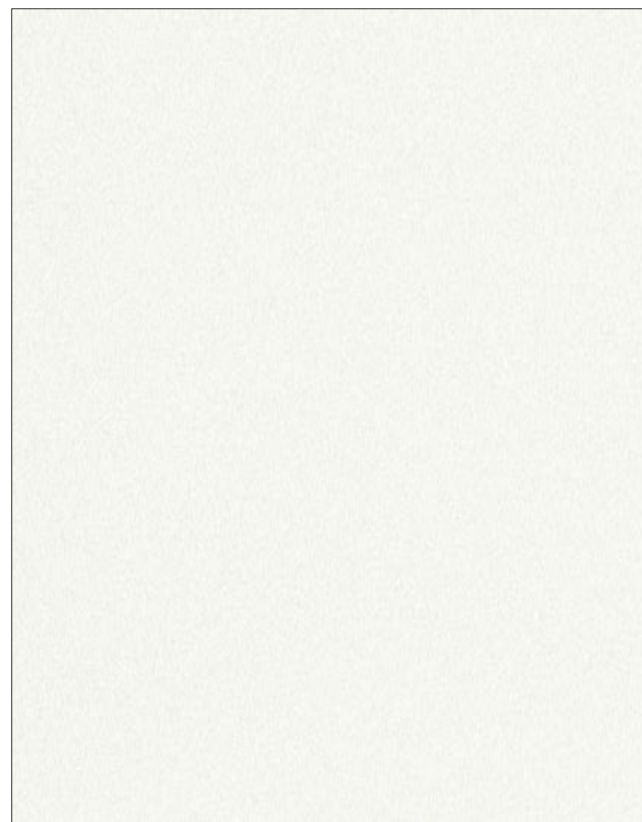

Finitura goffrato fine (opzionale)
Finish embossed (optional)
Terminer en relief (sur demande)

Verificare su mazzetta i colori reali. Sul sito www.otcdoors.com il pdf del catalogo per una miglior visualizzazione delle immagini.
Check the real colors on the fan. On the website www.otcdoors.com the pdf of the catalog for a better visualization of the images.
Vérifiez les vraies couleurs sur le ventilateur. Sur le site www.otcdoors.com le pdf du catalogue pour une meilleure visualisation des images.



AFRODITE

Laccati RAL

Finitura lucida e opaca raggrinzata antigraffio
Anti-scratch wrinkled glossy and matte finish
Finition brillante et mate froissée anti-rayures

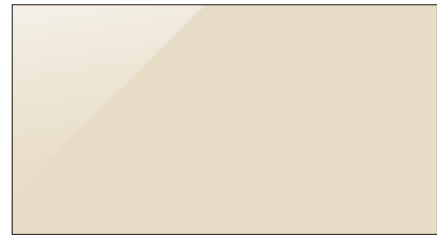

RAL 1013



RAL 1013 Grinz



RAL 1019



RAL 1019 GRINZ



RAL 3003



RAL 3003 GRINZ



RAL 3004



RAL 3004 GRINZ



RAL 3005

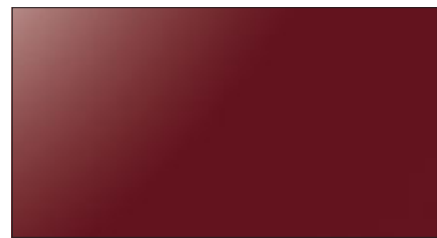

RAL 3005 GRINZ



RAL 5014



RAL 5014 GRINZ



RAL 5003



RAL 5003 GRINZ



RAL 6021

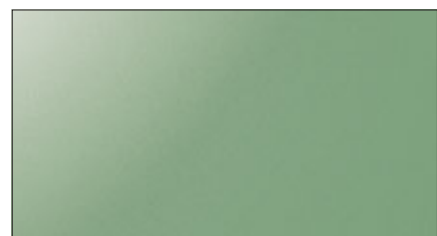

RAL 6021 GRINZ



RAL 6005



RAL 6005 GRINZ



RAL 6009



RAL 6009 GRINZ



RAL 7001



RAL 7001 GRINZ



RAL 7004



RAL 7004 GRINZ



RAL 7005



RAL 7005 GRINZ



RAL 7006



RAL 7006 GRINZ



RAL 7011

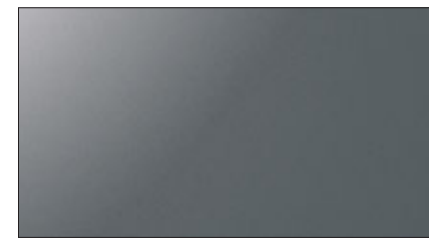

RAL 7011 GRINZ

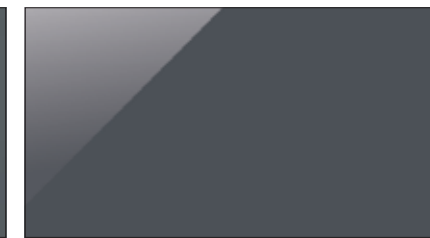

RAL 7015

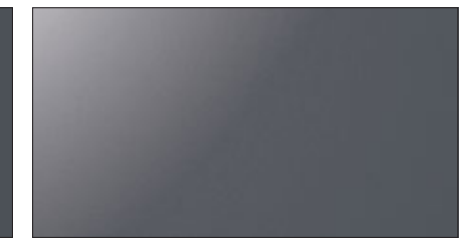

RAL 7015 GRINZ



RAL 7016

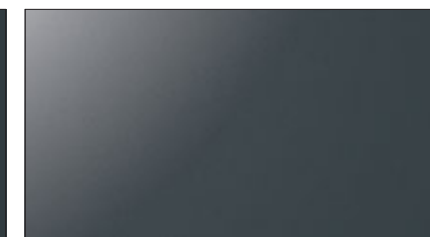

RAL 7016 GRINZ



RAL 7030

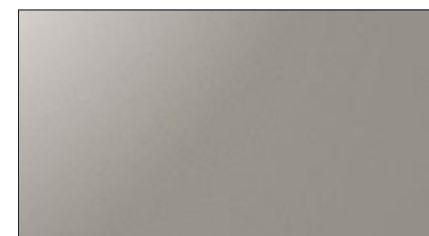

RAL 7030 GRINZ

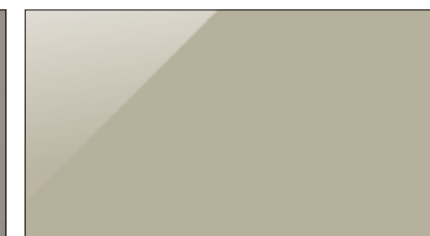

RAL 7032

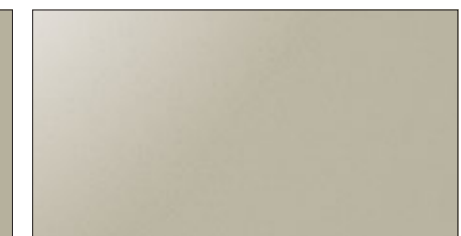

RAL 7032 GRINZ



RAL 7035

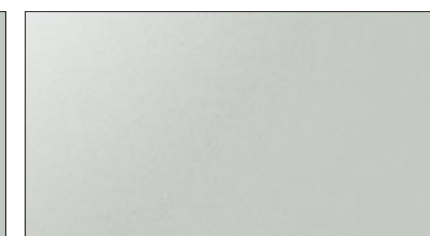

RAL 7035 GRINZ



RAL 7038

Verificare su mazzetta i colori reali. Sul sito www.otcdoors.com il pdf del catalogo per una miglior visualizzazione delle immagini.
Check the real colors on the fan. On the website www.otcdoors.com the pdf of the catalog for a better visualization of the images.
Vérifiez les vraies couleurs sur le ventilateur. Sur le site www.otcdoors.com le pdf du catalogue pour une meilleure visualisation des images.



RAL 7038 GRINZ

RAL 7040

RAL 7040 GRINZ

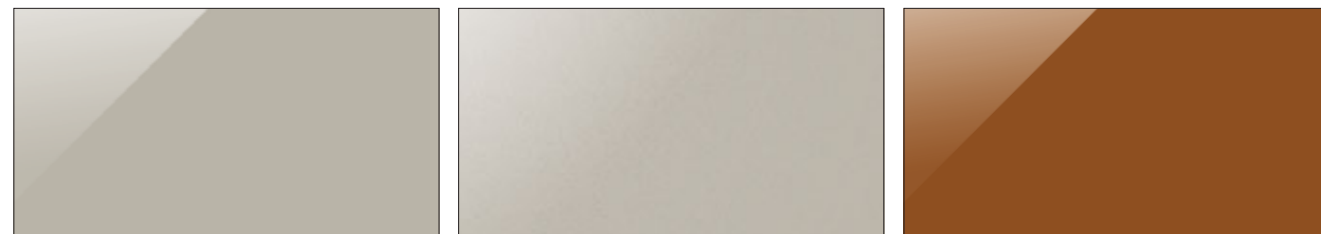

RAL 7044

RAL 7044 GRINZ

RAL 8003



RAL 8003 GRINZ

RAL 8011

RAL 8011 GRINZ



RAL 8014

RAL 8014 GRINZ

RAL 8017



RAL 8017 GRINZ

RAL 8019

RAL 8019 GRINZ

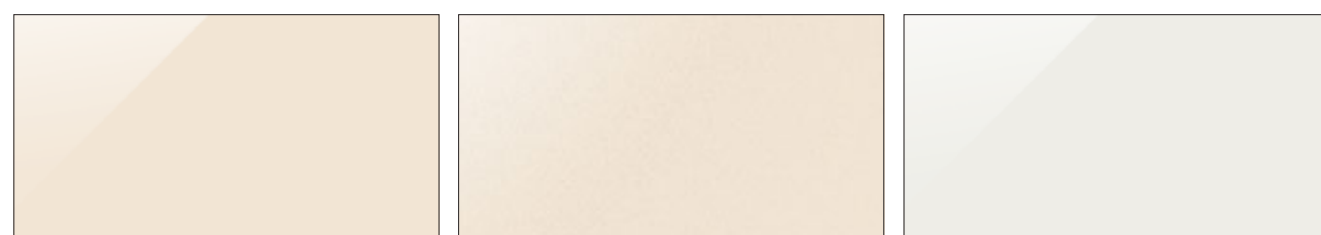

RAL 9001

RAL 9001 GRINZ

RAL 9003



RAL 9003 GRINZ

RAL 9005

RAL 9005 GRINZ

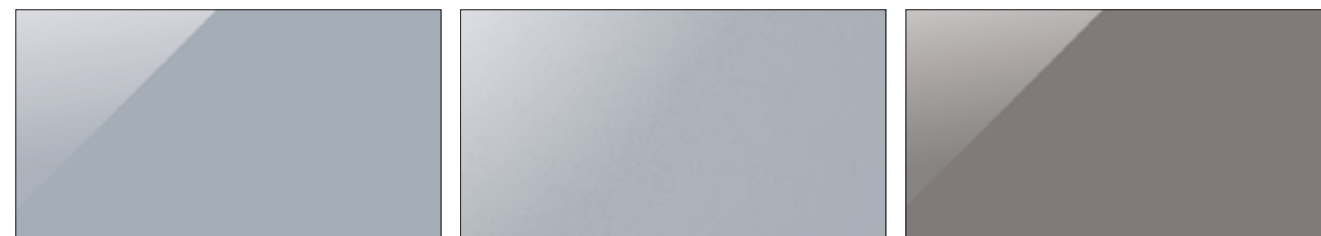

RAL 9006

RAL 9006 GRINZ

RAL 9007

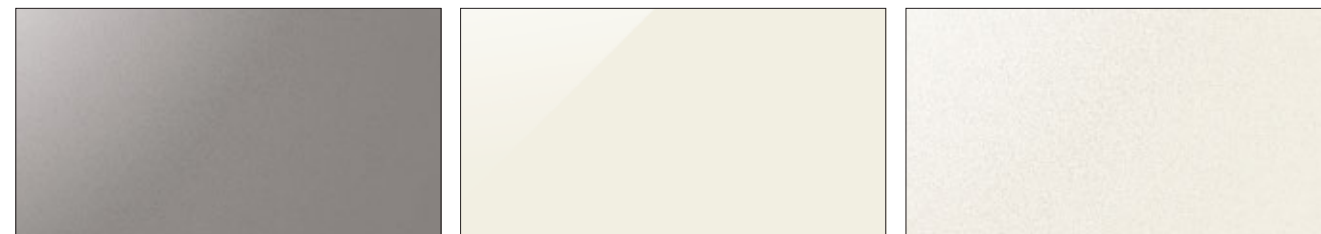

RAL 9007 GRINZ

RAL 9010

RAL 9010 GRINZ

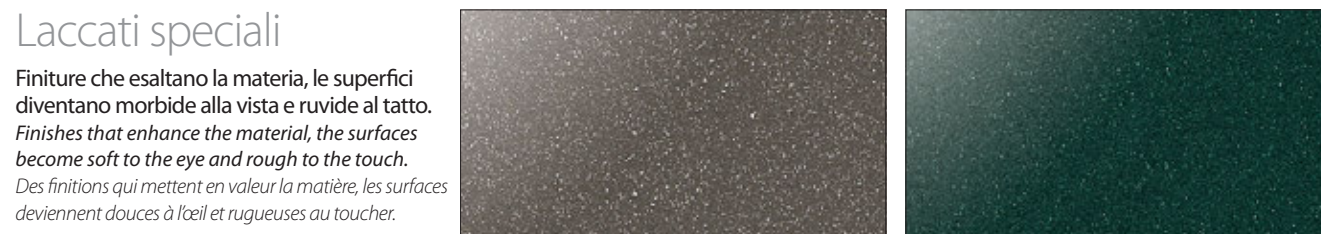

Grigio P7003 Grinz Mix

Verde P7103 Grinz Mix



Marrone P7203 Grinz Mix

Rosso P7300 Mix

Melon AK37V Grinz



Orange AK38V Grinz

Porpora AK39V Grinz

Avorio AK16V Grinz

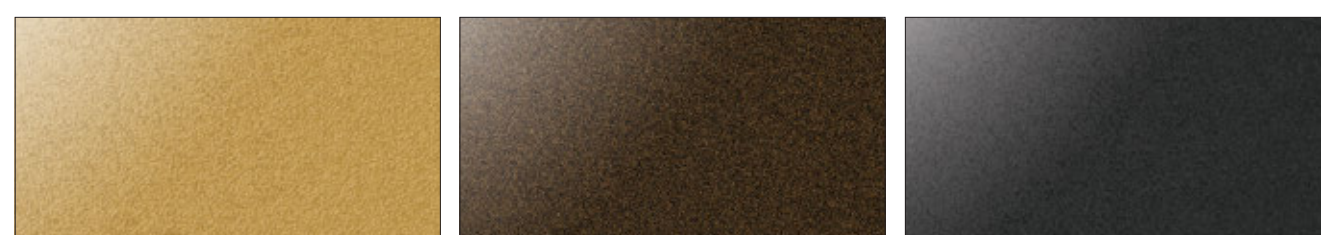

Ambra AK40V Grinz

Bronzo TR03V Grinz

Antracite P016V Grinz



Bleu AK15V Grinz

Bianco P7503 Grinz Mix

Beige AK12V Grinz Mix

Laccati speciali

Finiture che esaltano la materia, le superfici diventano morbide alla vista e ruvide al tatto. Finishes that enhance the material, the surfaces become soft to the eye and rough to the touch. Des finitions qui mettent en valeur la matière, les surfaces deviennent douces à l'œil et rugueuses au toucher.



Grigio P7003 Grinz Mix

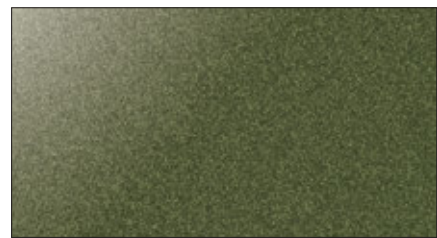

Salvia AK11V Grinz Mix

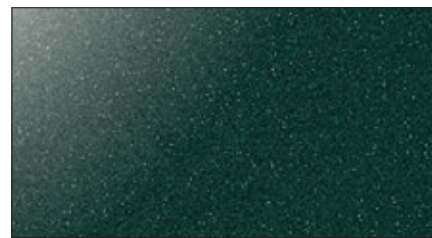

Verde P7103 Grinz Mix

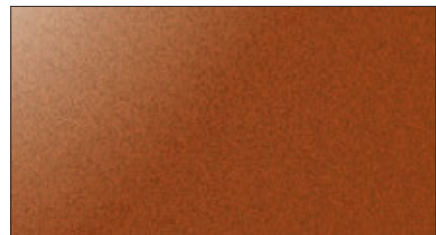

Corten AK10V Grinz Mix



Corten V001V Grinz Mix

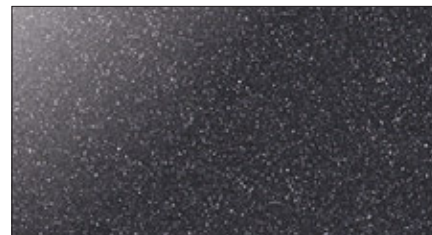

Marrone P7203 Grinz Mix

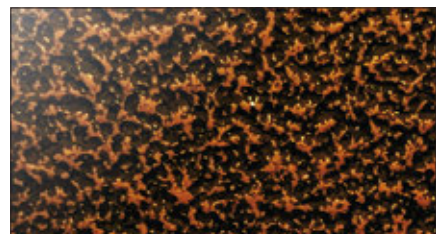

Rame bugnato AK02V

Pellicolati

Pellicole decorative applicate con laminazione a freddo sulle lastre di alluminio pretrattato.
Finishes made with applied decorative films with cold rolling on aluminum plates pretreated.
Finitions réalisées avec des films décoratifs appliqués avec laminage à froid sur plaques d'aluminium prétraité.



Weiss 915205-168



Cremeweiss 1379 20.11.01-167

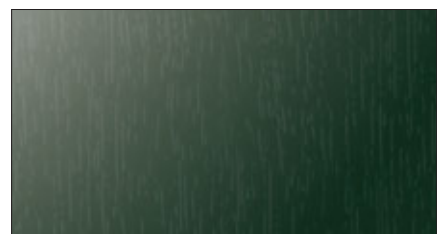

Dunkelgrun 6125 11.61.09-167



Sheffield Oak Light F4563081



Eiche Hell 2052 090-167



Siena PL 49 254-148



Winchester XA 49 240-148

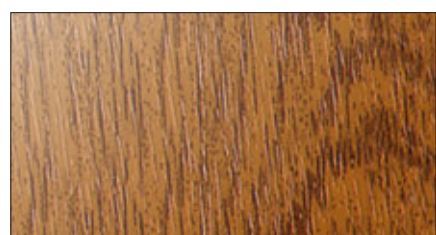

Golden Oak 2178 001-167

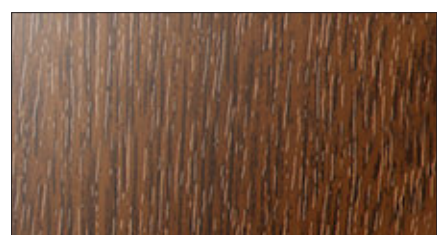

Nussbaum V 2178 007-167

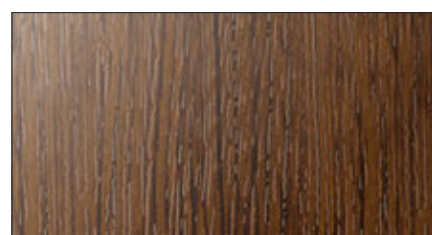

Eiche Rustikal 1 3149 008-167

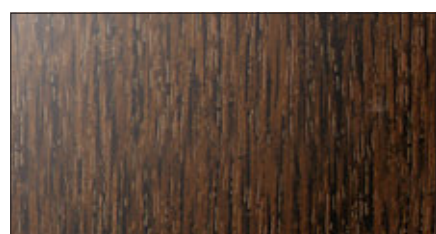

Eiche Dunkel FL-F1 2052 089-167



Mahagoni 2097 013-167



Black Cherry 3202 001-167

Alluminio sublimato

Emozioni estetiche che superano la bellezza dei materiali naturali che tende ad imitare.
Aesthetic emotions that go beyond the beauty of the natural materials that it tends to imitate.
Des émotions esthétiques qui vont au-delà de la beauté des matériaux naturels qu'elle tend à imiter.

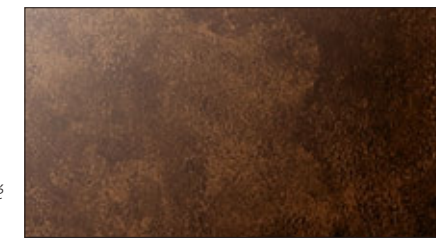

Corten RP101M

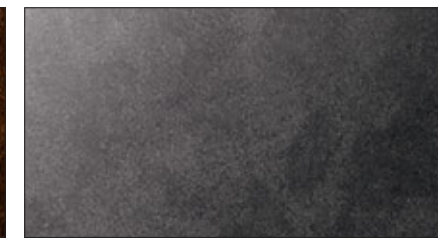

Ghisa RP102M



Cemento RP103M



Abete bianco RP14L



Rovere grigio RP10L

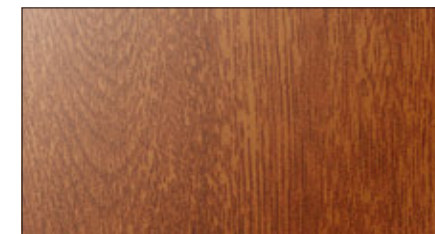

Ciliegio PVC - RP04L

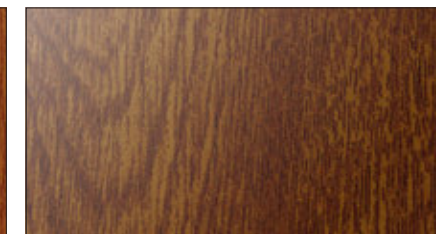

Noce PVC - RP06L

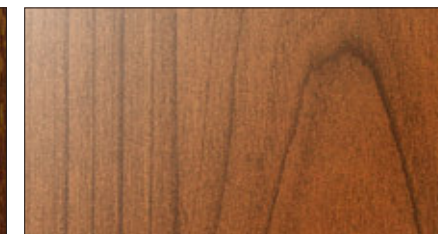

Ciliegio chiaro RP03L

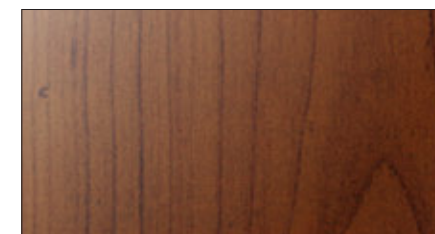

Ciliegio scuro RP02L

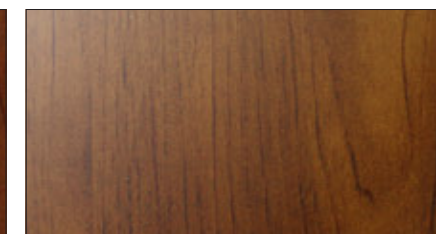

Castagno RP01L

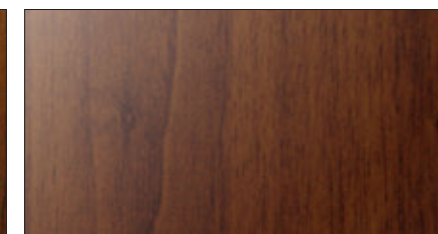

Noce chiaro RP08L

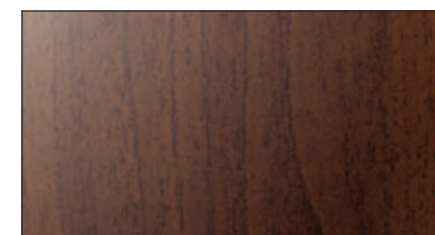

Noce medio RP07L

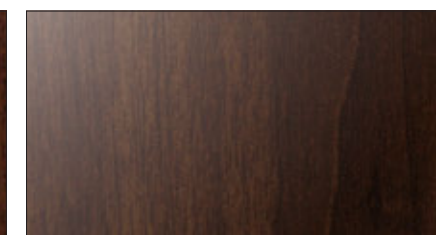

Noce scuro RP05L

POSEIDONE

Dalle importanti prestazioni contro agenti atmosferici, elementi corrosivi e raggi UV garantite dall'affidabilità delle pellicole Renolit, i pannelli Poseidone sono disponibili in una vasta gamma di varianti cromatiche e finiture superficiali in grado di soddisfare qualsiasi esigenza estetica.
With outstanding performance against atmospheric agents, corrosive elements and UV rays guaranteed by the reliability of Renolit films, Poseidone panels are available in a wide range of color variations and surface finishes capable of satisfying any aesthetic requirement.

Avec des performances exceptionnelles contre les agents atmosphériques, les éléments corrosifs et les rayons UV garanties par la fiabilité des films Renolit, les panneaux Poseidone sont disponibles dans une large gamme de variations de couleurs et de finitions de surface capables de satisfaire toutes les exigences esthétiques.



Agate Grey 7038



Aluminium Brush Effect

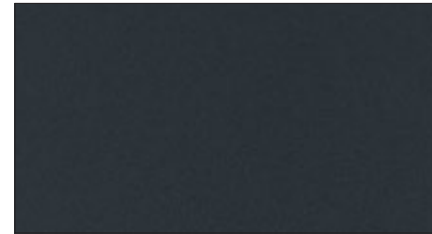

Anthracite Grey 7016

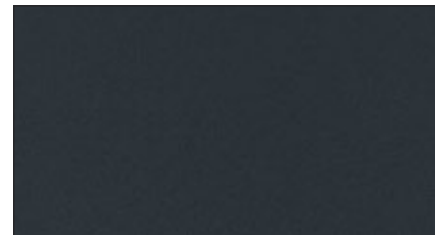

Anthracite Grey 7016 Smooth 2

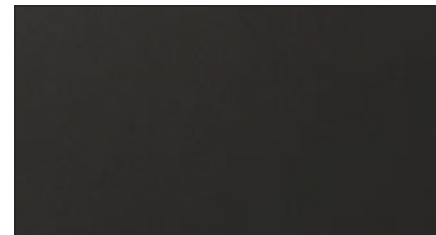

Ash C 35 N Smooth

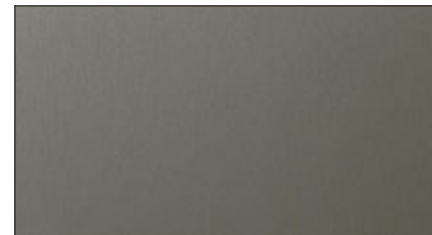

Asphalt 7342

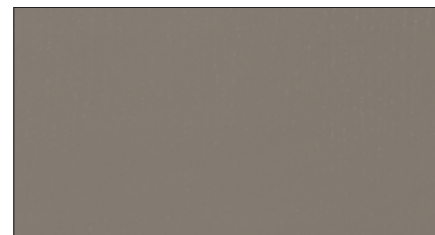

Balmoral



Basalt Grey 7012

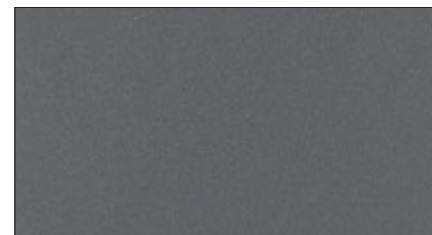

Basalt Grey 2012 Smooth 2

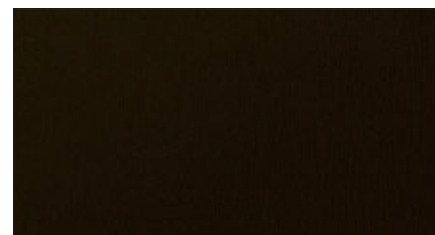

Black Brown 8518



Black Cherry

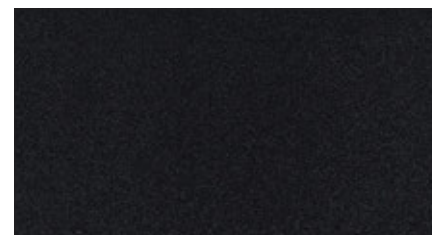

Black Grey 7021 Smooth 2

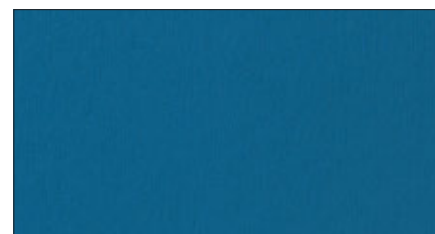

Brilliant Blue 5007

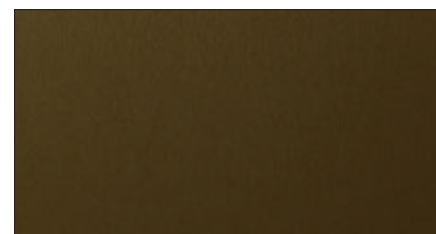

Bronze Platinum 1

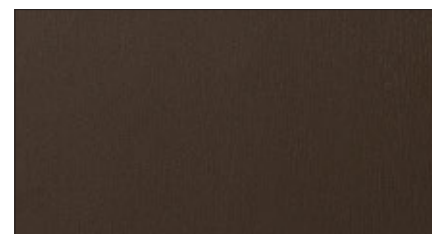

Brown 8972



Buckingham Grey

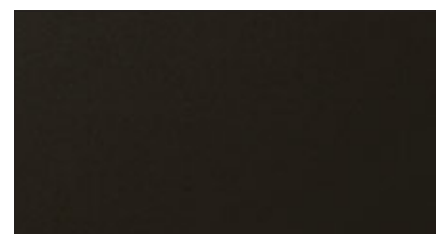

Ceylon C 34 N Smooth



Chartwell Green

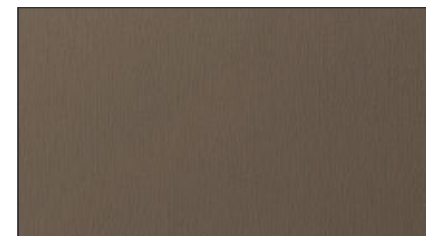

Choco-Brown-8210.jpg

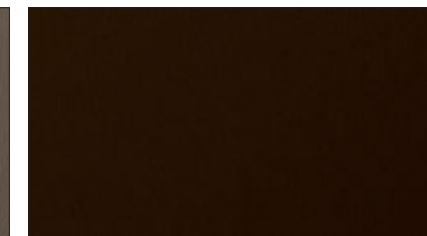

Chocolate-Brown_8875.jpg

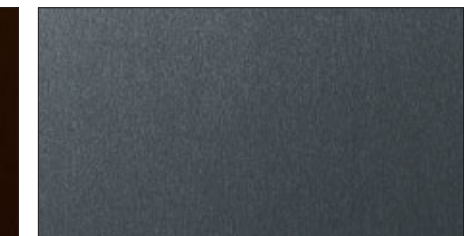

Crown-Platinum.jpg

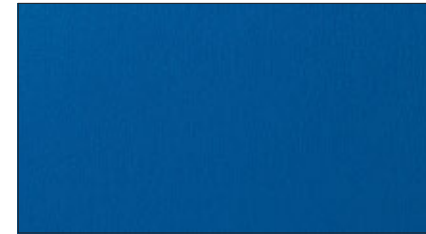

Dark-Blue-5030.jpg

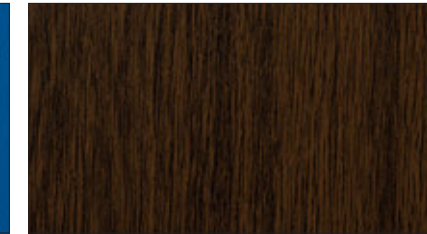

Dark-Oak-FL-F1.jpg



Dark-Red_3081.jpg

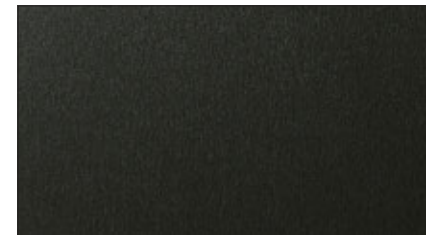

Earl-Platinum.jpg

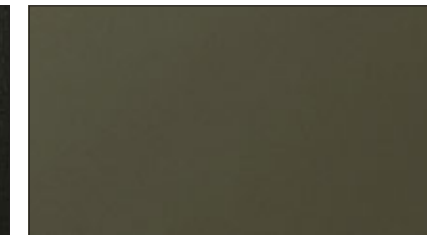

Flemish-Gold-C-33-N-Smooth.jpg

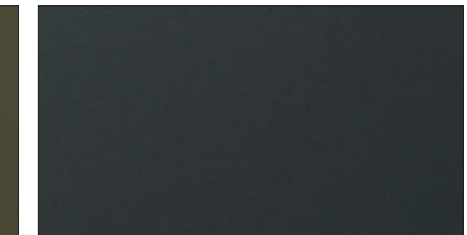

Gale-Grey-Finesse.jpg

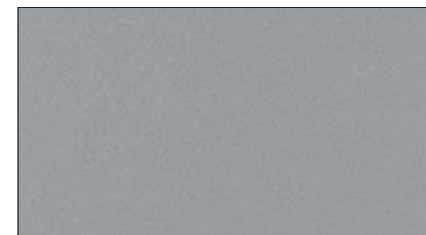

Grey_7155_Smooth-2.jpg

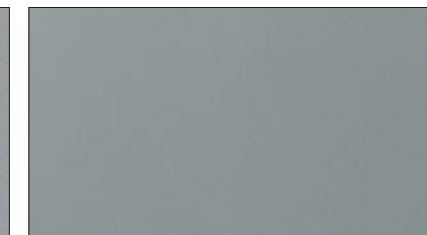

Hazy-Grey-Finesse.jpg

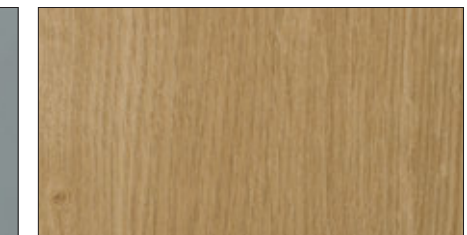

Irish-Oak.jpg



Iron-Glimmer-Anthracite-Skito.jpg

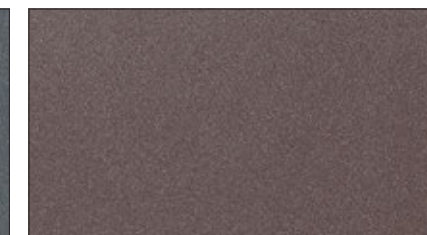

Iron-Glimmer-Brown-Skito.jpg



Iron-Glimmer-Slate-Skito.jpg

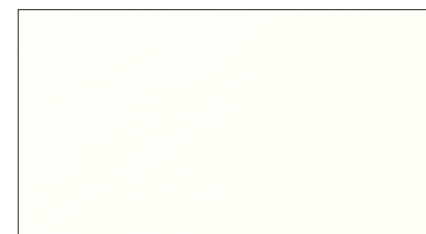

Iron-Glimmer-White.jpg

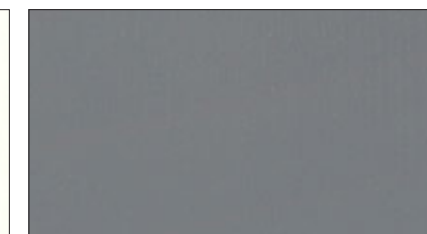

Kensington-Grey.jpg

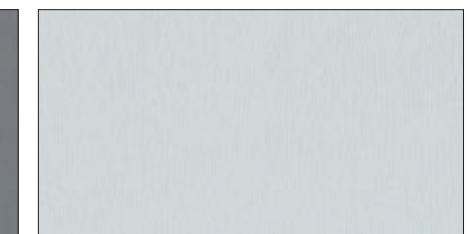

Light-Grey_7251.jpg



Light-Ivory_1015.jpg

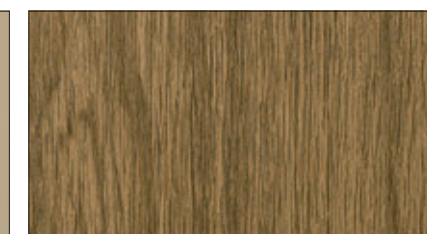

Light-Oak.jpg

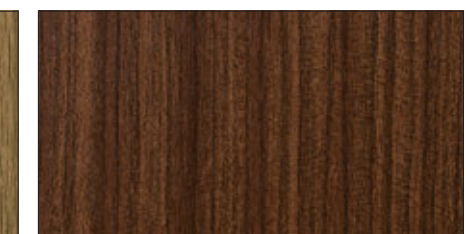

Macoré.jpg

Verificare su mazzetta i colori reali. Sul sito www.otcdoors.com il pdf del catalogo per una miglior visualizzazione delle immagini.

Check the real colors on the fan. On the website www.otcdoors.com the pdf of the catalog for a better visualization of the images.

Vérifiez les vraies couleurs sur le ventilateur. Sur le site www.otcdoors.com le pdf du catalogue pour une meilleure visualisation des images.

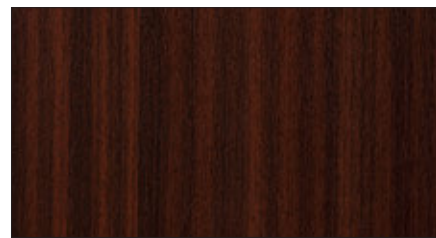

Mahogany.jpg

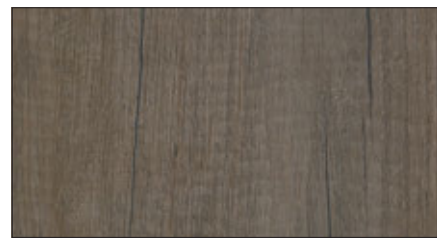

Monument-Oak.jpg

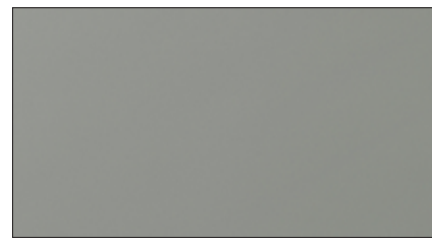

Moondance C-31N Smooth.jpg



Moss-Green_-6005.jpg



Mountain-Oak.jpg

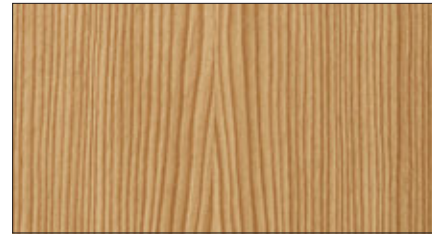

Mountain-Pine.jpg



Natural-Oak FL-G.jpg



Oregon Pine 4



Pyrite.jpg

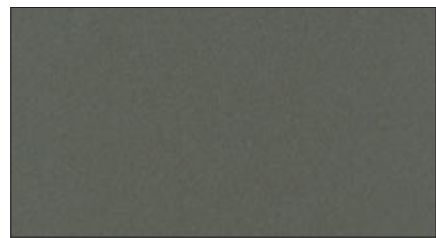

Quartz Grey 7039.jpg

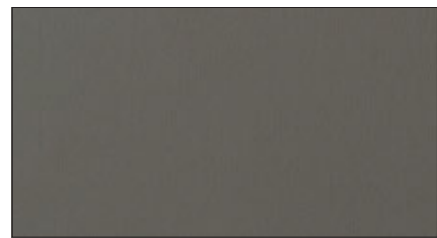

Quartz Grey 7039 Smooth 2.jpg

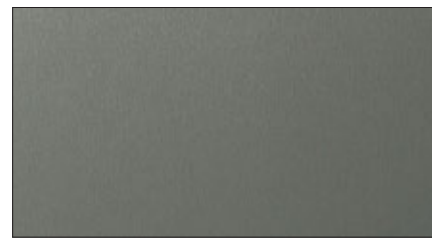

Quartz-Platinum.jpg



Rustic-Cherry.jpg

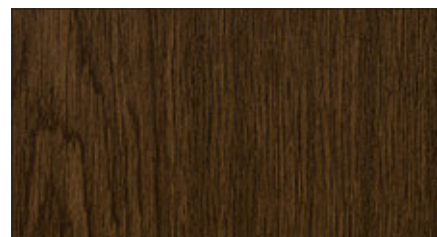

Rustic-Oak-1.jpg

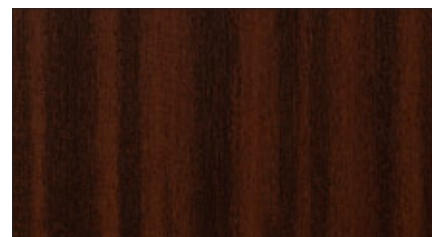

Sapeli.jpg

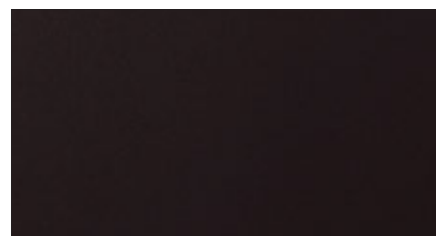

Shadow-Black-Smooth.jpg

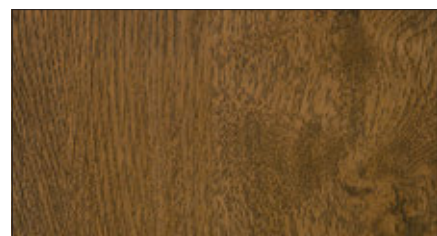

Sherwood-G.jpg



Shogun-AC.jpg

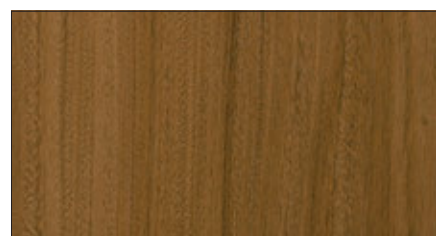

Shogun-AD.jpg

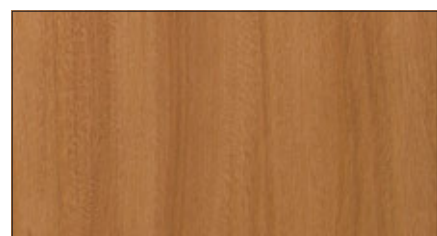

Shogun-AF.jpg

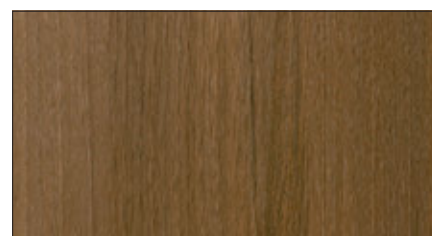

Siena-PL.jpg

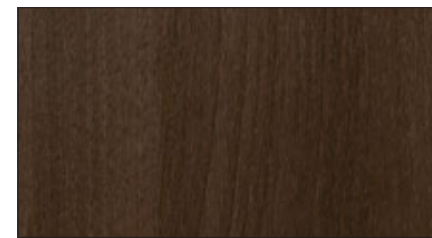

Siena-PN.jpg

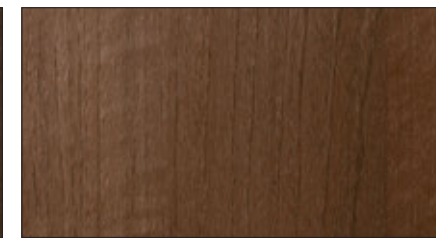

Siena-PR.jpg

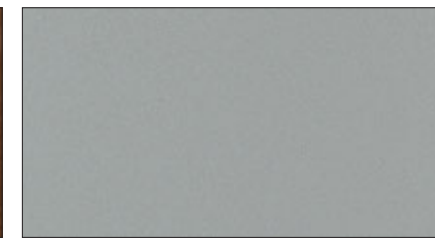

Signal-Grey_7004_Smooth-2.jpg



Silver-Brush-Effect.jpg



Silver-D-Smooth.jpg



Silver-V-9705.jpg



Slate-Grey.jpg



Slate-Grey_7015_Smooth-2.jpg

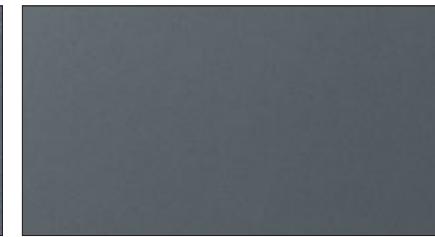

Slate-Grey-Finesse.jpg

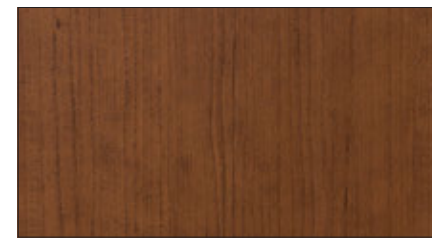

Soft-Cherry.jpg

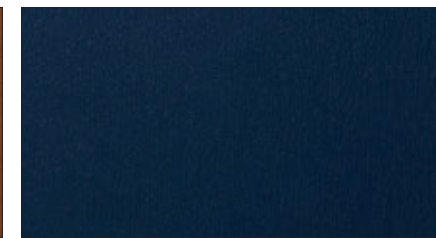

Steel-Blue_5150.jpg

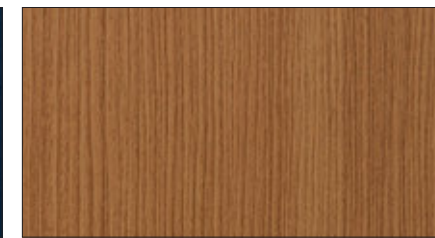

Stripe-Douglas-Fir.jpg

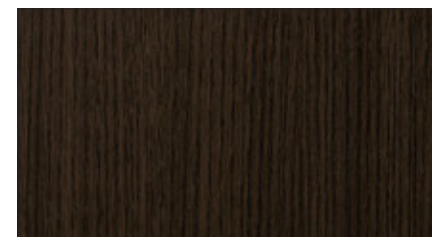

Swamp-Oak-St-F.jpg



Trojan Oak.jpg

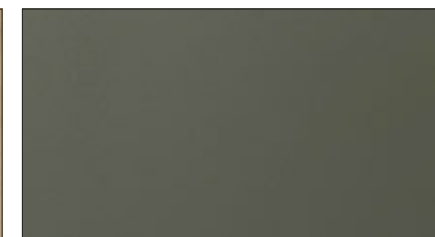

Trompet-C-32-N-Smooth.jpg

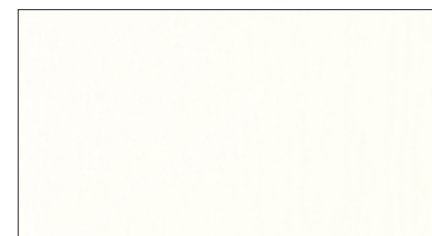

White 9152.jpg

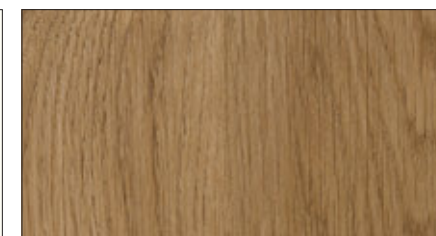

Winchester-XA.jpg



Winchester-XC.jpg

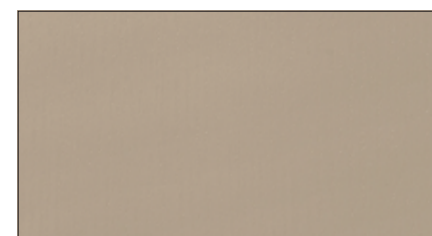

Windsor.jpg

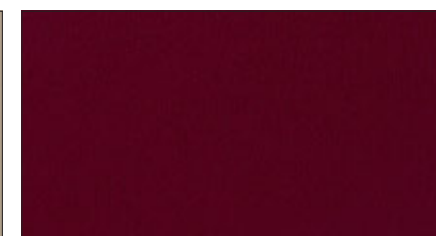

Wine-Red_3005.jpg

Verificare su mazzetta i colori reali. Sul sito www.otcdoors.com il pdf del catalogo per una miglior visualizzazione delle immagini.
Check the real colors on the fan. On the website www.otcdoors.com the pdf of the catalog for a better visualization of the images.
Vérifiez les vraies couleurs sur le ventilateur. Sur le site www.otcdoors.com le pdf du catalogue pour une meilleure visualisation des images.

Tutte le illustrazioni del catalogo, e le descrizioni dei prodotti, sono puramente indicative. ITP DOORS srl declina ogni eventuale variazione cromatica che venga riscontrata sul prodotto e che non corrisponda alle immagini presenti a catalogo, ricordando che i colori per loro stessa natura potrebbero risultare differenti da quelli illustrati. ITP DOORS srl si riserva il diritto di apportare modifiche ai prodotti, in qualsiasi momento e senza preavviso, al fine di migliorare la produttività e la funzionalità del prodotto. La riproduzione anche parziale delle immagini è vietata a norma di legge. Le tecniche di stampa e di fotografia non consentono una perfetta e fedele riproduzione dei colori, devono quindi essere considerati puramente indicativi e a livello pubblicitario. ITP DOORS srl non accetterà pertanto, alcun reclamo per eventuali differenze tra merce fornita e materiale pubblicitario.

All illustrations in the catalog, and product descriptions are purely of an indicative nature. ITP DOORS srl disclaims responsibility for any variation in product colors that does not correspond to the images shown in the catalog, and points out that colors by their very nature may be different from those shown. We reserve the right to make changes at any time and without notice in order to improve product features and productivity. The reproduction of images, even partially, is prohibited by law. Printing and photographic techniques do not allow perfect and faithful color reproduction, and should, therefore, be considered merely as guidelines and as advertising. ITP DOORS srl will not accept, therefore, any claim for any discrepancies arising between goods supplied and advertising material.

Toutes les illustrations dans le catalogue ainsi que les descriptions des produits ne sont fournies qu'à titre purement indicatif. ITP DOORS srl décline toute variante éventuelle dans la couleur d'un produit ne correspondant pas exactement aux illustrations du catalogue, tout en soulignant que les couleurs par leur nature même, peuvent être différentes de celles des illustrations. Nous nous réservons le droit d'apporter des modifications sur nos produits à tout moment et sans préavis, afin d'améliorer leur productivité et caractéristiques. La reproduction, même partielle, des images est interdite par la loi. Les techniques d'impression et de photographie ne peuvent rendre une reproduction parfaite et fidèle des couleurs, et doivent donc être considérées comme étant à titre purement indicatif et d'un niveau publicitaire. Par conséquent ITP DOORS srl ne sera pas en mesure d'accepter des réclamations concernant d'éventuelles différences entre les marchandises livrées et le matériel publicitaire.